

2485 Natomas Park Drive, Suite 600
Sacramento, California 95833-2937
United States
T +1.916.920.0300
F +1.916.920.8463
www.jacobs.com

Subject PFAS Potential Source Investigation

Prepared for Zone 7 Water Agency

From Jacobs

Date December 4, 2020

Copies to Colleen Winey, Carol Mahoney/Zone 7 Water Agency

This technical memorandum (TM) was prepared to support identification of potential sources of per- and polyfluoroalkyl substances (PFAS) detected in groundwater production and monitoring wells in the Zone 7 Water Agency (Zone 7) service area. The TM summarizes the data review and potential PFAS source identification activities completed for the Potential PFAS Source Investigation (Project) and is organized into the following sections:

- Background
- Review of Existing Data
- Evaluation of Potential PFAS Sources
- Summary of Findings and Recommendations
- References

1. Background

Zone 7 has observed PFAS in samples collected from groundwater production wells in their service area. Perfluorooctanesulfonic acid (PFOS) has been detected above the California State Water Resources Control Board (SWRCB) Division of Drinking Water (DDW) notification level (NL) of 6.5 nanograms per liter (ng/L) or parts per trillion (ppt) in 8 of Zone 7's 10 groundwater production wells, as well as the City of Pleasanton's 3 active wells, and 1 of the California Water Service's (CWS's) 10 active production wells in Livermore. Perfluorooctanoic acid (PFOA) has also been detected above the NL of 5.1 ng/L in four Zone 7 and two City of Pleasanton production wells. Concentrations in five groundwater production wells have exceeded the DDW response level (RL) of 40 ng/L for PFOS. Water from some wells recently has been blended or treated to meet the previous combined (PFOS + PFOA) RL of 70 ppt. In addition to PFOS and PFOA, other PFAS compounds have been detected in groundwater production wells in the Zone 7 service area.

In response to PFAS detections in their groundwater production wells, Zone 7 has conducted multiple rounds of PFAS sampling at select monitoring wells surrounding the impacted production wells and in areas where surrounding land use/historical activities may have resulted in the release of PFAS compounds into the environment. The depth profiles of PFAS concentrations in many of the nested monitoring wells have been variable and do not follow a regular pattern of decreasing (or increasing)

concentration with depth. There is an upper and lower aquifer system in the area. The Zone 7 production wells generally pump from the lower aquifer. Monitoring wells are screened in both the upper and lower aquifers as well as a deep aquifer that is not utilized for municipal supply purposes.

The purpose of the Project is to review existing PFAS results and other hydrogeologic data provided by Zone 7 to evaluate the distribution of PFAS in groundwater and simultaneously identify potential PFAS sources. The objectives of the Project are to:

- Develop an improved understanding of the extent of the PFAS contamination.
- Evaluate why vertical patterns of PFAS concentrations observed at some nested well locations do not show consistent trends.
- Identify potential sources of the observed PFAS contamination.
- Consider whether the PFAS contamination could be coming from a continuous/persistent source or if it is potentially a slug moving through the groundwater system from a single release event.
- Identify data gaps and provide recommendations for additional work.

2. Review of Existing Data

Zone 7 provided Jacobs with a database that is an extensive repository of groundwater elevations, PFAS water quality results, well construction information, and other water quality results. Zone 7 also provided previous reports containing geologic and hydrogeologic cross-sections. Jacobs reviewed the data along with other publicly available data from the DDW and California Department of Water Resources (DWR) Sustainable Groundwater Management Act (SGMA) Data Viewer to assess the current distribution of PFAS laterally and vertically in the local aquifer units.

2.1 Summary of the Local Hydrogeology

The Livermore Valley Groundwater Basin has been divided into three management areas: Main Basin, Fringe Subareas, and Upland Areas. This Project focused primarily on the Main Basin management area because that is where the municipal supply wells are located. As a result, the majority of groundwater wells sampled for PFAS are in the Main Basin. The Main Basin occupies the central portion of the Livermore-Amador Valley (Valley) floor with an area of about 19,000 acres (Zone 7, 2020). The Main Basin is subdivided into four subbasins, in order from west to east, as follows: Castle Subbasin, Bernal Subbasin, Amador Subbasin, and the Mocho II Subbasin. Figure 1 shows the three management areas, including the Main Basin and subbasins, along with the wells used for this investigation.

The Main Basin is hydraulically connected to the surrounding fringe areas through the shallow alluvium; however, subsurface inflow from the Fringe Subareas into the deeper aquifer units is considered to be minor due to subsurface geologic barriers (Zone 7, 2020). The Upland Management Areas have been defined by areas where recent alluvium is absent and the Livermore Formation and other older water-bearing bedrock units are exposed (Zone 7, 2020). Most of the precipitation that falls on the Upper Management Areas exits those areas as runoff that flows into the streams in the Fringe and Main Basin management areas (Zone 7, 2020). A small portion of deep percolation may contribute to the Main Basin as subsurface inflow (Zone 7, 2020).

The two primary aquifers zones within the Main Basin are the Upper and Lower Aquifers. The two zones are separated by a silty clay aquitard that is presented on the geologic cross-sections that have been prepared by Zone 7 and are included with this TM as Attachment A. Attachment A-1 shows cross-sections ZA-ZA', ZB-ZB', ZC-ZC', and the cross-section location map. Attachment A-2 shows cross-section ZD-ZD'. The deepest portion of the Lower Aquifer corresponds to the water-bearing units of the Livermore Formation, which is considered the Deep Aquifer. Zone 7 does not have any production wells producing from this zone and it is monitored by five Zone 7 nested monitoring wells within the Amador Subbasin.

The aquitard that separates the Upper and Lower Aquifers ranges from less than 5 feet up to 50 feet thick and is observed at a depth ranging from approximately 80 to 175 feet below ground surface (bgs). Based on review of the cross-sections, some existing and future lakes appear to penetrate the aquitard. Zone 7 has also identified hydrostratigraphic units that correspond to the Upper and Lower Aquifers. The Upper Aquifer is identified as the cyan unit, and the Lower Aquifer is composed of the gray, purple, and red units, as shown on the cross-sections. The portion of the red unit below the municipal supply wells is considered the Deep Aquifer. These geologic cross-sections were also modified to show the vertical groundwater hydraulic gradients where recent groundwater elevation data and PFAS sampling results were available.

Four hydrogeologic cross-sections were used for our analysis: the north to southeast trending ZA-ZA', north to south trending ZB-ZB', northeast to south trending ZC-ZC', and the northwest to southeast trending ZD-ZD' (Attachments A-1 and A-2). These cross-sections were developed in 2011 and indicate the location of current and future mining lakes. Some of the mining lakes identified as "future" have been excavated or partially excavated, but reclamation is not complete. The cross-sections show nine nested monitoring wells that were used for the vertical hydraulic gradient calculations. The spring groundwater elevations were mostly from May 2019 but some were included from May 2018 and 2020. The most recent data provided in the Zone 7 database, at the time of this analysis, were used. The fall groundwater measurements were from September 2019. The fall measurements were used to determine any change in the vertical hydraulic gradients when compared to the spring measurements.

For each of the cross-sections, the PFAS data were shown for spring and the vertical hydraulic gradients were shown for spring with a comparison to the gradient for fall. The red arrows indicate the spring and fall gradients are the same and point in the direction of the gradient from high to low. If the vertical hydraulic gradient on Attachment A-1 is a blue arrow, it indicates that the fall gradient is the opposite of what is shown on the figure. PFAS data for Lakes I, H, and Cope were available in the Zone 7 database and are also shown on the cross-sections. For wells or lakes without data, "NA" was written next to the feature indicating data were not available.

2.1.1 Groundwater Production

Zone 7 has a conjunctive use strategy, which is an integrated management of surface and groundwater. During periods when surface water is plentiful, excess water supply can be used to recharge the groundwater aquifers. During periods of limited surface water supply, more groundwater may be used, including recovery of surface water recharged during wet years. Because of this management strategy, the amount of groundwater produced in the Main Basin can vary from year to year.

Zone 7 produces groundwater from the Lower Aquifer using 10 active wells located in the Amador and Bernal Subbasins. The active production wells are shown on Figure 1; their locations in the Basin are summarized below:

- Amador Subbasin: Production wells in the Amador Subbasin include Chain of Lakes 1 (COL1), Chain of Lakes 2 (COL2), and Chain of Lakes 5 (COL5), which surround Lake H, Stoneridge 1 (St1), Mocho 1 (M1), Mocho 2 (M2), Mocho 3 (M3), and Mocho 4 (M4), located west of the lakes along Arroyo Mocho.
- Bernal Subbasin: Production wells in the Bernal Subbasin include Hopyard 6 (H6) and Hopyard 9 (H9), located south of the confluence of Arroyo Mocho and Chabot Canal.

In 2019, Zone 7 pumped about 8,666 acre-feet (AF) of groundwater from their 10 active wells with an average annual production volume of 5,300 AF between 1974 and 2019. During the same period, Zone 7 has recharged 74,326 AF more than it has pumped. From fall 2018 to fall 2019, the Main Basin water balance indicated a 3,881-AF increase in groundwater storage (Zone 7, 2020).

Additional groundwater is produced from other agencies and well owners within the Main Basin and these volumes are not included in the usage data presented above. The surface water imported to Zone 7 comes from their State Water Project (SWP) allocation, which makes up an average of 75 percent of their supply and in 2019 accounted for 61 percent (Zone 7, 2020). The total water produced and used in Livermore Valley was 27 percent groundwater, 61 percent surface water, and 12 percent recycled water.

Zone 7 provided PFAS results for a subset of production wells operated by other water purveyors in the Basin, including wells owned by the City of Pleasanton (Pleasanton Well 5 [P5], Pleasanton Well 6 [P6], and Pleasanton Well 8 [P8]) and CWS Well 19 (CWS 19). The locations of these wells are shown on Figure 1.

2.1.2 Biosolids Land Application and Recycled Water

Recycled water is primarily used within the Livermore Valley and Main Basin for landscape irrigation. The primary sources for recycled water within the Main Basin are the Livermore Wastewater Reclamation Plant (LWRP) and the Dublin San Ramon Services District (DSRSD), both of which produce secondary- and tertiary-treated effluent (Zone 7, 2020). LWRP and DSRSD contributed 505 AF and 370 AF, respectively, of recycled water that was applied to the Main Basin as landscape irrigation in 2019. Below is a general description of these two treatment facilities.

2.1.2.1 Dublin San Ramon Services District Treatment Facilities

Wastewater from the Cities of Dublin, Pleasanton, and southern San Ramon is treated at the DSRSD regional wastewater treatment plant (WWTP). The DSRSD regional plant is a conventional activated sludge secondary treatment facility that operates under National Pollutant Discharge Elimination System (NPDES) Permit No. CA 0037613 and discharges secondary treated effluent to the San Francisco Bay. The City of Pleasanton owns and operates all of the sewer pipelines and pumping stations within Pleasanton that are required to deliver the City's wastewater to the DSRSD treatment plant. The plant can provide secondary treatment for an average daily dry weather design flow of 17.0 million gallons per day (mgd). The plant also receives up to 3.2 mgd of reverse osmosis reject water from the Alameda County Flood

Control and Water Conservation District (Zone 7 Water Agency). The reject water is combined with the plant effluent after secondary treatment and disinfection, and before effluent compliance monitoring location.

Sludge is thickened by dissolved air floatation, anaerobically digested, and treated in six onsite sludge lagoons for approximately 5 years. The treated sludge is injected into soil at an onsite disposal area (SFRWQCB, 2017). The land disposal area is regulated under Waste Discharge Requirements (WDRs) Order No. R2-2007-0053. This facility consists of a 55-acre dedicated land disposal (DLD) area used to dispose biosolids. The DLD site was formed by injecting treated biosolids directly into the ground surface and incorporation of the biosolids into the soil for disposal. The DLD site terrain is flat and is surrounded by a berm averaging approximately 8 feet high. Areas surrounding the site are predominantly commercial and residential. The DLD site is an unlined land treatment unit.

According to the WDRs, the DLD biosolids land treatment unit includes general provisions and tasks necessary to establish design criteria for the biosolids containment, and to establish monitoring programs to minimize impacts to water quality. The DLD site has received biosolids from one or more facultative sludge lagoons (FSLs) yearly since 1989. Biosolids are stabilized in the FSLs for a minimum of 4 years. During the summer months, the biosolids are dredged and transported by pipeline to the DLD site. The biosolids are placed into furrows approximately 8 to 12 inches deep and immediately covered with soil to avoid odorous conditions. Approximately 1,375 dry tons of biosolids are placed into the DLD site per year.

The biosolids disposed at the DLD site are classified as "designated waste" (nonmunicipal, nonhazardous waste) pursuant to the criteria set forth in California Code of Regulations Title 27 Section 20210. No other waste materials are disposed at the DLD site. The DLD site meets the requirements for a Land Treatment Unit as specified in Title 27, Section 20250(bX5).

In 2016, the DSRSD prepared a Master Plan to evaluate several alternatives to potentially discontinue using the DLD, or FSLs and DLD in the future. Concerns over the loading capacity of the FSLs and the DLD units, as well as future regulatory requirements, are some of the drivers to explore alternatives to the current operation of the solids stabilization, dewatering, and disposal.

Exhibit 1 shows the FSL and DLD areas at the DSRSD.

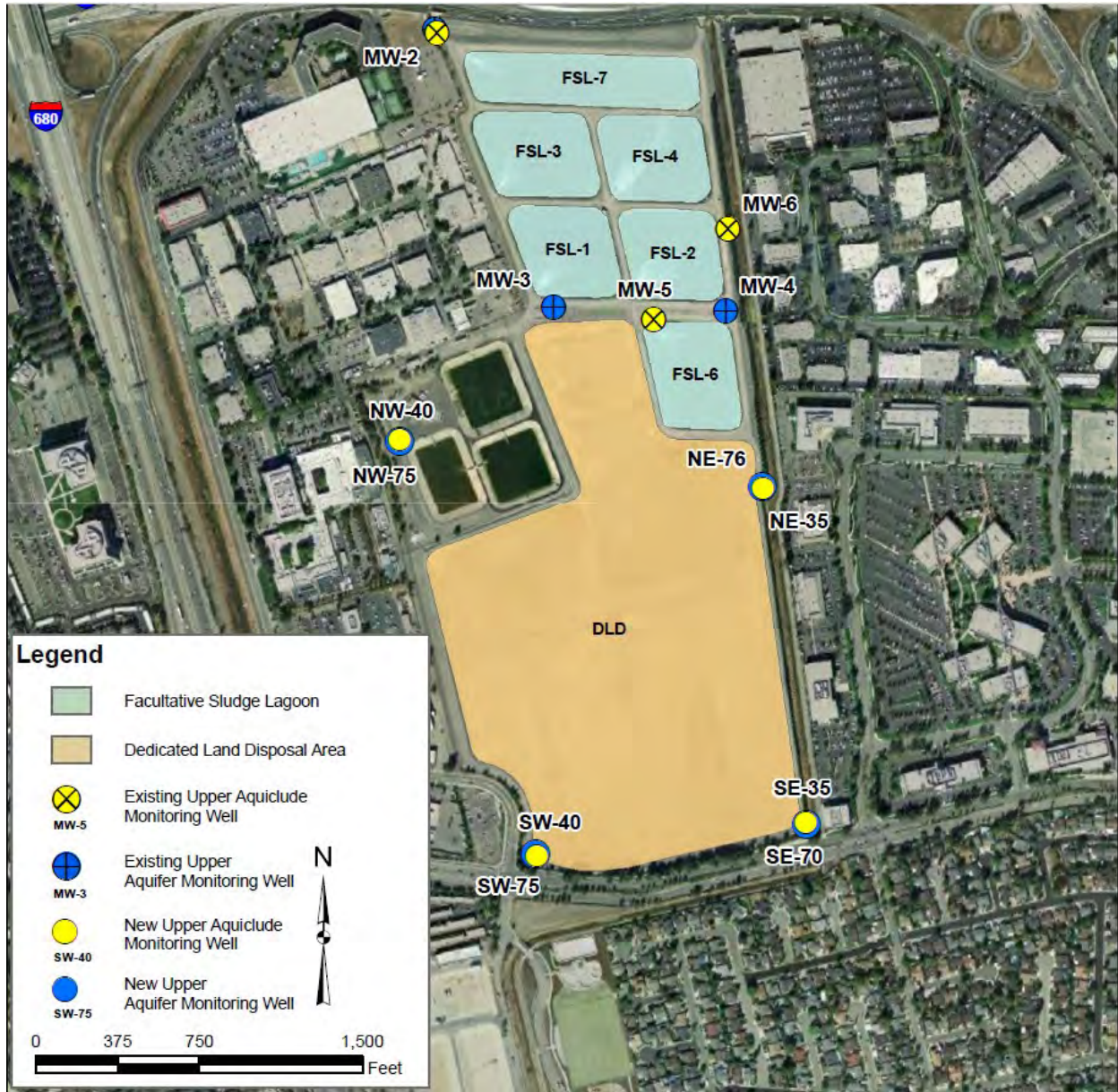


Exhibit 1. DSRSD Facultative Sludge Lagoons and Dedicated Land Disposal Areas (Luhdorff & Scalmanini, 2017)

The DSRSD regional WWTP produces disinfected tertiary recycled water that meets California Title 22 requirements. DSRSD and East Bay Municipal Utility District (EBMUD) work under a Joint Powers Agreement that formed the DSRSD/EBMUD Recycled Water Authority (DERWA). The tertiary recycled water facilities located at the DSRSD WWTP are owned and operated by DSRSD. The tertiary process uses coagulation, flocculation, sand filters, and ultraviolet (SF-UV) light disinfection to treat secondary effluent at flows between 2.5 to 9.7 mgd, during periods of high demand. Microfiltration combined with ultraviolet (MF-UV) light disinfection are used during periods of low demand, when daily demand falls below 2 mgd, mostly during the months of November to February. The MF-UV flow capacity is limited to 3 mgd. Exhibit 2 provides a process flow diagram of the recycled water treatment facilities at DSRSD.

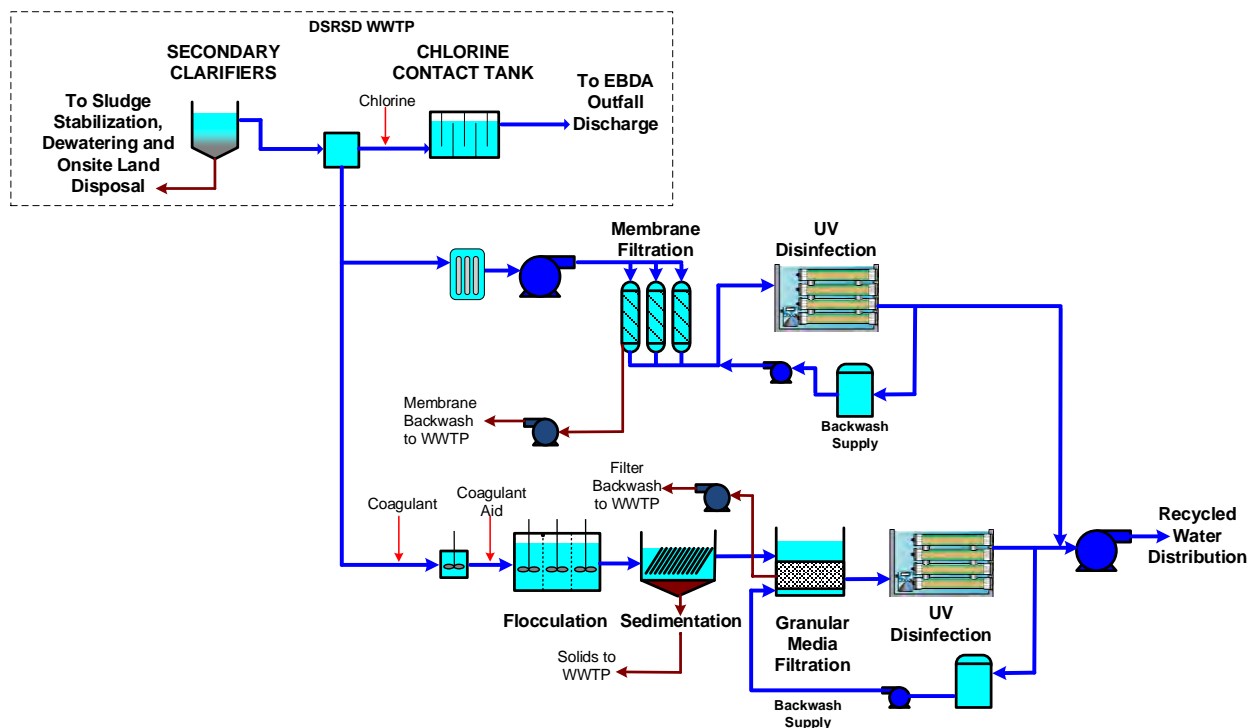


Exhibit 2. Process Flow Diagram of Recycled Water Treatment Facilities at DSRSD

The 2016 Master Plan looked at a range of potable reuse alternatives to meet DSRSD's policy to increase the reliability of the water supply by diversifying the water supply portfolio. Three options considered for end uses were: (1) groundwater recharge, (2) surface water augmentation, or (3) advanced water treatment discharge directly into the potable water system. Each of these three options would require advance treatment facilities.

2.1.2.2 Livermore Water Reclamation Plant

The LWRP produces disinfected tertiary recycled water that meets California Title 22 requirements. The LWRP consists of a conventional activated sludge treatment process. After secondary treatment, a portion of the flow is directed toward the tertiary treatment process while the remaining flow continues to the secondary effluent chlorine contact tank before being discharged to the San Francisco Bay. The LWRP

tertiary treatment process schematic is shown in Exhibit 3. In addition to the secondary treatment train, a parallel treatment consists of pumping secondary effluent to two flocculation tanks where polymer is added before entering the deep bed granular media filters. Filtered water is then conveyed through the UV disinfection system. A maximum flow of recycled water available for unrestricted irrigation in the City of Pleasanton is approximately 1.7 mgd (maximum month basis).

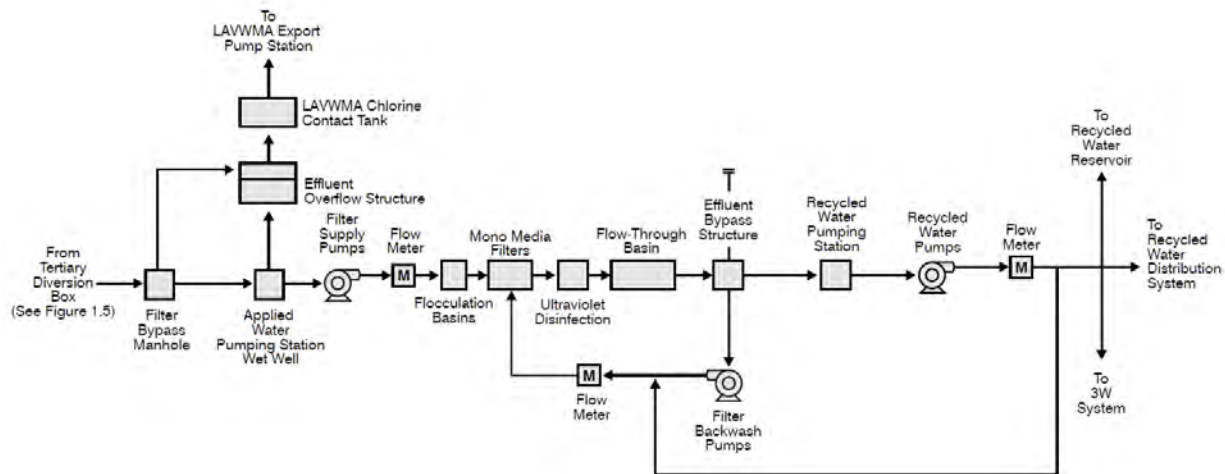


Exhibit 3. Tertiary Treatment Process Schematic for LWRP

According to the 2019 Annual Report, an additional 652 AF of wastewater leaches into the Main Basin from the Veterans Administration Hospital onsite sewage treatment plant (50 AF), septic tanks (80 AF), and pipe leakage (522 AF) (Zone 7, 2020).

The locations where the recycled water is applied are shown on Figure 2. The majority of the recycled water in the Main Basin is from the LWRP, and is primarily applied in areas north and east of the lakes.

2.1.3 Mining Operations

The active gravel mining operations in the Main Basin dewater certain pits that are part of the Chain of Lakes in the Amador Subbasin. Attachment B (Figure 4-1) shows the locations of the gravel mining pits, their status, mining area lakes, and groundwater elevation contours for the Upper Aquifer. Mine dewatering activities lower groundwater levels in both the Upper and Lower Aquifers directly beneath the active pits, at this time Lake E and Lake D, and cause a large depression in the potentiometric surface surrounding the pits.

Historically, the mining operations discharged to surface water under an NPDES permit to the Arroyo Mocho and Arroyo Valley. We understand that the current practice is to convey the groundwater that is pumped during dewatering activities to a series of nearby clay-lined lakes, including Lake F and Lake G, to settle out fines, at which point the water is pumped to Cope Lake. A pipeline conveys water from Cope Lake to Lake I to recharge groundwater. The majority of the Zone 7 monitoring and production wells that have been sampled for PFAS are near the northern side of these lakes. The lakes and the wells that have

been sampled for PFAS are shown on Figure 1. Select lakes are projected onto the geologic cross-sections, which show some of the lakes penetrating the Upper Aquifer and extending into the Lower Aquifer.

2.2 Groundwater Flow Conditions

Regionally, groundwater flow in the Main Basin is from east to west in both the Upper and Lower Aquifers. Figures 3 and 4 show the fall 2019 groundwater elevation contours prepared by Zone 7 for the Upper and Lower Aquifers, respectively. Observations regarding groundwater flow conditions in the Upper and Lower Aquifers include the following:

- In the Mocho II Subbasin, groundwater elevations in the Upper Aquifer are generally 20 to 30 feet higher compared to the Lower Aquifer, and west/southwest flow directions (toward Lakes E and D where the mines are dewatering) are observed in both aquifers.
- In the Amador Subbasin near Lake E and D, where dewatering is taking place, the difference in groundwater elevation between the two aquifers increases to approximately 50 to 80 feet, the gradient steepens, and groundwater flow is to the southwest toward Lake E.
- In the southern portion of the Amador Subbasin, the groundwater elevation difference is approximately 30 to 60 feet, and groundwater flows in a northwest direction toward the depression formed near Lake D.
- On the western side of the Amador Subbasin, west of the active mine pits and the Chain of Lakes area, the groundwater gradient becomes flatter and groundwater flow continues to the west and southwest.
- Groundwater mounding is observed in the Lower Aquifer in the area surrounding Lake I. This mounding could indicate that discharges to Lake I are recharging the Lower Aquifer.

The difference in head observed between the Upper and Lower Aquifer indicates a degree of hydraulic separation. Vertical hydraulic gradients were calculated for nine multi-level monitoring wells, consisting of a total of 31 discrete monitoring depths, with groundwater level data to determine the vertical movement of groundwater between the Upper and Lower Aquifers, and within the Lower Aquifer. Water level data from the monitoring wells were compared in spring and fall. The direction of flow in each of the wells is shown on the geologic cross-sections in Attachments A-1 and A-2.

The general trend observed is that of a downward vertical hydraulic gradient from the Upper Aquifer to the upper portion of the Lower Aquifer. Nested wells surrounding Lake I, including 9P9 through 9P11, 9J7 through 9J9, and 10B8 through 10B11, as shown on cross-section ZD-ZD' (Attachment A-2), show a general downward gradient from the Upper Aquifer to the Lower Aquifer and within the upper portion of Lower Aquifer, which correlates to the pumping depressions observed in the groundwater contours for both aquifers. Cross-section ZC-ZC' (Attachment A-1) on the eastern edge of the mining operation near the boundary of the Amador and Mocho II Subbasins indicate a general upward vertical gradient from the lowest sections of the Lower Aquifer to upper portions of the Lower Aquifer. Cross-sections ZA-ZA' and ZB-ZB' (Attachment A-1) show varying vertical gradients within the Lower Aquifer, indicating upward and downward gradients.

2.3 Distribution of PFAS in Groundwater

Zone 7 initially analyzed samples from COL1 and M2 for PFAS compounds in 2013. Wells in Zone 7 were not analyzed for PFAS again until a more comprehensive round of biannual sampling began in 2018. In 2019, Zone 7 also expanded their PFAS sampling to include a network of monitoring wells, including nested monitoring wells. By 2020, the Zone 7 water quality database included PFAS results for one domestic well, 55 monitoring wells, and 14 municipal wells in the Main Basin.

Currently, Zone 7 analyzes for the following 18 different PFAS compounds:

- 11-chloroeicosafuoro-3-oxaundecane-1-sulfonic acid (11Cl-PF30UdS)
- 9-chlorohexadecafluoro-3-oxanone-1-sulfonic acid (9Cl-PF30NS)
- 4,8-dioxa-3H-perfluorononanoate (ADONA)
- 2,3,3,3-tetrafluoro-2-(heptafluoropropoxy) propanoic acid (HFPO-DA)
- N-ethyl perfluorooctanesulfonamido acetic acid (NEtFOSAA)
- N-methyl perfluorooctanesulfonamido acetic acid (NMeFOSAA)
- perfluorobutane sulfonic acid (PFBS)
- perfluorodecanoic acid (PFDA)
- perfluorododecanoic acid (PFDoA)
- perfluoroheptanoic acid (PFHpA)
- perfluorohexanoic acid (PFHxA)
- perfluorohexane sulfonic acid (PFHxS)
- perfluorononanoic acid (PFNA)
- perfluorooctanoic acid (PFOA)
- perfluorooctane sulfonic acid (PFOS)
- perfluorotetradecanoic acid (PFTA)
- perfluorotridecanoic acid (PFTTrDA)
- perfluoroundecanoic acid (PFUnA)

PFAS sample results for municipal production wells and monitoring and domestic wells are included in Tables 1 and 2, respectively. PFOS and PFOA are the only PFAS currently with NLs and RLs set by DDW. The NL for PFOS is 6.5 ng/L and the NL for PFOA is 5.1 ng/L. The RLs for PFOS and PFOA are 40 ng/L and 10 ng/L, respectively. Table 3 summarizes the number of wells sampled, number of wells where the analyte was detected, the number of wells where the NL and RL have been exceeded, the maximum concentration detected, and the well where the maximum detection was observed for each of the 18 PFAS compounds. (Tables 1 through 3 are provided at the end of this section.)

PFAS detections in municipal wells, monitoring/domestic wells, and the lakes included in the data provided by Zone 7 are summarized as follows:

- Municipal Wells
 - PFAS compounds have been detected in 12 of the 14 municipal wells sampled.
 - The PFOS concentration exceeded the NL in 12 wells, and the RL in 7 wells. A maximum PFOS concentration of 120 ng/L was detected in P8.

- The PFOA concentration exceeded the NL in five wells and has not exceeded the RL in a municipal well. A maximum PFOA concentration of 9.8 ng/L was detected in M1.
- Five additional PFAS compounds, including PFBS, PFHpA, PFHxA, PFHxS, and PFNA, have been detected in municipal wells. Of these compounds, PFHxS is typically detected at the highest concentrations. These compounds are currently not regulated in California drinking water. The maximum concentrations for these five compounds were observed in M1 or P8.
- **Monitoring and Domestic Wells**
 - Table 2 summarizes the results for 55 monitoring wells and one domestic well. No PFAS were detected in the domestic well.
 - PFAS compounds have been detected in 44 of the 55 monitoring wells.
 - The PFOS concentration exceeded the NL in 40 monitoring wells, and the RL in 17 monitoring wells. A maximum PFOS concentration of 1,200 ng/L was detected in 10B8, which is located along Arroyo Mocho, north of Lake I. Based on a review of cross-section ZD (Attachment A-2), 10B8 is screened across the aquitard that separates the Upper and Lower Aquifers.
 - The PFOA concentration exceeded the NL in 18 monitoring wells, and the RL in 10 monitoring wells. A maximum PFOA concentration of 36 ng/L was detected in 10B8.
 - The same five unregulated PFAS compounds detected in municipal wells have been detected in monitoring wells. Of these compounds, PFHxS is typically detected at the highest concentrations. The maximum concentrations for these additional PFAS compounds were observed in 10B8, except for PFNA; the highest concentration of PFNA was observed in 2R1, which is located at the Las Positas Golf Course, approximately 150 feet north of Livermore Airport, and is screened in the Upper Aquifer.
- **Lakes**
 - Three lakes were monitored in spring 2019 for PFAS; results were as follows:
 - 1) Cope Lake: PFOA 4.7 ng/L and PFOS 26 ng/L
 - 2) Lake H: PFOA 7.8 ng/L and PFOS 44 ng/L
 - 3) Lake I: PFOA 5.2 ng/L and PFOS 46 ng/L

The relative concentrations of different PFAS compounds detected in municipal and monitoring wells are generally consistent throughout the Main Basin, with PFOS and PFHxS typically having the highest concentrations at a given location. Figures 3, 4, and 5 show the distribution of PFAS in the Upper, Lower, and Deep Aquifers, respectively. The figures summarize the following information:

- Where PFOS has been detected for wells and where PFOS exceeds the NL or RL.
- Where PFOA has been detected for wells and where PFOA exceeds the NL or RL.
- Where other PFAS compounds have been detected.

Attachment B (Figures 7-11 and 7-12) includes interpreted PFOS plumes in the Upper and Lower Aquifers prepared by Zone 7. The following summarizes lateral distribution of PFOS and PFOA in the Upper, Lower, and Deep Aquifers.

- **Upper Aquifer:** The highest concentrations of PFOS and PFOA in the Upper Aquifer are generally observed in the areas surrounding and downgradient (west and south) of the Livermore Airport. PFOS, PFOA, and other PFAS compounds were typically detected together; however, only unregulated PFAS were detected at two locations (2M3 and 3G2) in the Camp Subbasin. Concentrations of PFOS and PFOA in the area west of the lakes are all below RLs.
- **Lower Aquifer:** The highest concentrations of PFOS and most of the wells that exceeded the PFOS RL are observed downgradient of the Livermore Airport and surrounding Lakes H and I. Wells upgradient (east and south) of the depression of the potentiometric surface surrounding the mining area generally exhibited lower PFAS concentrations. West of the mining area in the Bernal Subbasin, PFAS are not detected in the Lower Aquifer.
- **Deep Aquifer:** Five locations in the Deep Aquifer have been sampled for PFAS. The highest concentrations are observed in 11G4, located south of the airport and north of the mining area, where PFOS and PFOA exceeded RLs. Concentrations generally decline downgradient to the west. PFAS were not detected at two locations upgradient (east) of the mining area.

The vertical distribution of PFOS and PFOA in groundwater was evaluated using the hydrogeologic cross-sections included in Attachments A-1 and A-2. Sampling results for Zone 7 wells have been placed adjacent to their corresponding well and sampling depth in the geologic cross-sections. The results from sampling indicate that the concentrations of PFAS compounds do not follow an increasing or decreasing trend with depth and are not evenly distributed in the Upper and Lower Aquifers. The Zone 7 production wells have multiple screen intervals and the vertical hydraulic gradients are both downward and upward in different layers of the Lower Aquifer; this process may create a circulation of water from the Upper Aquifer into the Lower Aquifer.

In the area beneath the active mining pits where there are pumping depressions, some of the deepest screen zones have higher PFAS concentrations than intermediate zones. A steady increase in PFAS with depth was not observed, which suggests that the movement of PFAS between the aquifer units is complex and could be facilitated by migration from different aquifer zones through wells that are screened across multiple aquifer layers.

An example that illustrates the varying PFAS concentrations throughout different aquifer layers can be seen on cross-section ZB-ZB' (Attachment A-1) in the multi-completion monitoring well 3S-1E 11G1-4. Well 3S-1E 11G1 is screened in the Upper Aquifer and has a concentration of 210 ng/L for PFOS. The next deeper well is 3S-1E 11G2 in the upper portion of the Lower Aquifer and it has a PFOS concentration of 160 ng/L. The next deeper well is 3S-1E 11G3, which has a screen interval that is about 200 feet long and the PFOS concentration is 26 ng/L. The deepest zone for the multi-completion well is 3S-1E 11G4, which is in the lowest portion of the Lower Aquifer and has a PFOS concentration of 140 ng/L. The vertical gradient from 3S-1E 11G3 to 3S-1E 11G4 was downward in May but then reverses and was upward in September. The complex PFAS distribution and reversals in vertical flow patterns are likely the result of seasonal variability in recharge and pumping patterns at municipal wells and from mine dewatering.

Table 1. PFAS Results for Municipal Production Wells
 PFAS Potential Source Investigation, Zone 7 Water Agency

Well Name (Well No.)	Top of screen (ft bgs)	Bottom of screen (ft bgs)	Sample Date	PFOS (ng/L)	PFOA (ng/L)	11CI-PF3OUdS (ng/L)	9CI-PF3ONS (ng/L)	ADONA (ng/L)	HFPO-DA (ng/L)	NEtFOSAA (ng/L)	NMeFOSAA (ng/L)	PFBS (ng/L)	PFDA (ng/L)	PFDoA (ng/L)	PFHpA (ng/L)	PFHxA (ng/L)	PFHxS (ng/L)	PFNA (ng/L)	PFTA (ng/L)	PFTTrDA (ng/L)	PFUnA (ng/L)		
Main Basin - Amador Subbasin																							
Mocho 1 (3S/1E 9M 2)	150	510	2019-01-02	78	7.6	-	-	-	-	ND	ND	11	ND	ND	3.3	11	67	ND	ND	ND	ND		
			2019-01-22	86	7.9	-	-	-	-	-	-	-	-	-	-	-	-	-	-	-	-	-	
			2019-04-09	90	9.8	-	-	-	-	-	-	ND	ND	16	ND	ND	4.3	14	90	ND	ND	ND	ND
			2019-10-07	110	8.9	ND	ND	ND	ND	ND	ND	ND	ND	12	ND	ND	3.5	11	76	ND	ND	ND	ND
			2020	100	8.5	ND	ND	ND	ND	ND	ND	ND	ND	12	ND	ND	3.5	11	68	ND	ND	ND	ND
Mocho 2 (3S/1E 9M 3)	250	570	2013-05-22	11.9	-	-	-	-	-	-	-	-	-	-	-	-	-	17.5	-	-	-	-	
			2018-11-28	ND	ND	-	-	-	-	-	ND	ND	ND	ND	ND	ND	ND	ND	ND	ND	ND	ND	ND
			2019-04-08	46	5.6	-	-	-	-	-	-	ND	ND	8.6	ND	ND	2.3	7.4	42	ND	ND	ND	ND
			2019-04-17	50	6.1	-	-	-	-	-	-	ND	ND	7.7	ND	ND	2	7.2	47	ND	ND	ND	ND
			2019-10-07	50	5.9	ND	ND	ND	ND	ND	ND	ND	ND	8	ND	ND	2.7	7	43	ND	ND	ND	ND
2020	41	5.4	ND	ND	ND	ND	ND	ND	ND	ND	7.2	ND	ND	2.5	7.1	35	ND	ND	ND	ND			
Mocho 3 (3S/1E 9M 4)	315	493	2019-01-02	30	6	-	-	-	-	ND	ND	6.7	ND	ND	2.3	5.4	29	ND	ND	ND	ND		
			2019-01-22	26	5.2	-	-	-	-	-	-	-	-	-	-	-	-	-	-	-	-	-	
			2019-04-09	32	5.8	-	-	-	-	-	-	ND	ND	7.2	ND	ND	2.7	6.9	30	ND	ND	ND	ND
			2019-08-05	35	5.6	ND	ND	ND	ND	ND	ND	ND	ND	6.4	ND	ND	2.4	5.6	28	ND	ND	ND	ND
			2019-10-07	39	5.7	ND	ND	ND	ND	ND	ND	ND	ND	6.6	ND	ND	2.5	5.8	31	ND	ND	ND	ND
2020	30	5	ND	ND	ND	ND	ND	ND	ND	ND	5.2	ND	ND	2.2	5.2	22	ND	ND	ND	ND			
Mocho 4 (3S/1E 8H18)	515	730	2018-12-04	9.1	3	-	-	-	-	ND	ND	5.7	ND	ND	ND	4	18	ND	ND	ND	ND		
			2019-04-09	4.4	3.3	-	-	-	-	-	ND	ND	5.7	ND	ND	ND	4.4	17	ND	ND	ND	ND	
			2019-10-07	14	3.6	ND	ND	ND	ND	ND	ND	ND	ND	4.8	ND	ND	ND	3.7	16	ND	ND	ND	ND
			2020	12	2.6	ND	ND	ND	ND	ND	ND	ND	ND	4.5	ND	ND	ND	3.4	14	ND	ND	ND	ND
Stoneridge 1 (3S/1E 9B 1)	250	800	2018-12-04	8.9	ND	-	-	-	-	ND	ND	3.1	ND	ND	ND	ND	13	ND	ND	ND	ND		
			2019-04-09	4.8	ND	-	-	-	-	-	ND	ND	2.8	ND	ND	ND	ND	9.8	ND	ND	ND	ND	
			2019-07-09	12	2	ND	ND	ND	ND	ND	ND	ND	ND	3.6	ND	ND	ND	2.4	13	ND	ND	ND	ND
			2020	7.7	ND	ND	ND	ND	ND	ND	ND	ND	ND	2.9	ND	ND	ND	ND	9.2	ND	ND	ND	ND
Chain of Lakes 1 (3S/1E 10K 3)	205	530	2013-05-22	6.4	-	-	-	-	-	-	-	-	-	-	-	-	-	7.1	-	-	-	-	
			2018-11-28	32	4.7	-	-	-	-	-	ND	ND	5.3	ND	ND	2	5.4	29	ND	ND	ND	ND	
			2019-01-02	25	4.1	-	-	-	-	-	ND	ND	4.8	ND	ND	ND	5.1	24	ND	ND	ND	ND	
			2019-04-08	29	3.7	-	-	-	-	-	ND	ND	4.5	ND	ND	ND	4	23	ND	ND	ND	ND	
			2019-07-09	44	6.2	ND	ND	ND	ND	ND	ND	ND	ND	6.5	ND	ND	2.2	6.6	34	ND	ND	ND	ND
2020	28	4	ND	ND	ND	ND	ND	ND	ND	ND	4.3	ND	ND	ND	4	21	ND	ND	ND	ND			
Chain of Lakes 2 (3S/1E 11M 3)	345	684	2019-01-02	12	2.4	-	-	-	-	ND	ND	2.8	ND	ND	ND	2.5	12	ND	ND	ND	ND		
			2019-01-22	16	3	-	-	-	-	-	-	-	-	-	-	-	-	-	-	-	-	-	
			2019-04-08	12	ND	-	-	-	-	-	ND	ND	2.5	ND	ND	ND	2.2	11	ND	ND	ND	ND	
			2019-07-09	15	2.9	ND	ND	ND	ND	ND	ND	ND	ND	3.2	ND	ND	ND	2.8	14	ND	ND	ND	ND
			2019-10-08	16	2.8	ND	ND	ND	ND	ND	ND	ND	ND	3.4	ND	ND	ND	2.8	14	ND	ND	ND	ND
2020	13	2.1	ND	ND	ND	ND	ND	ND	ND	ND	2.9	ND	ND	ND	2.4	12	ND	ND	ND	ND			
Chain of Lakes 5 (3S/1E 10B16)	390	690	2019-01-02	23	ND	-	-	-	-	ND	ND	2.2	ND	ND	ND	2	15	ND	ND	ND	ND		
			2019-01-22	35	ND	-	-	-	-	-	-	-	-	-	-	-	-	-	-	-	-	-	
			2019-04-08	52	2	-	-	-	-	-	ND	ND	3.7	ND	ND	ND	3.6	28	ND	ND	ND	ND	
			2019-07-09	42	2.2	ND	ND	ND	ND	ND	ND	ND	ND	2.8	ND	ND	ND	2.6	24	ND	ND	ND	ND
			2019-10-08	40	ND	ND	ND	ND	ND	ND	ND	ND	ND	2.6	ND	ND	ND	2.9	20	ND	ND	ND	ND
2020	15	ND	ND	ND	ND	ND	ND	ND	ND	ND	ND	ND	ND	ND	9.2	ND	ND	ND	ND	ND			

Table 1. PFAS Results for Municipal Production Wells

PFAS Potential Source Investigation, Zone 7 Water Agency

Well Name (Well No.)	Top of screen (ft bgs)	Bottom of screen (ft bgs)	Sample Date	PFOS (ng/L)	PFOA (ng/L)	11CI-PF3OUdS (ng/L)	9CI-PF3ONS (ng/L)	ADONA (ng/L)	HFPO-DA (ng/L)	NEtFOSAA (ng/L)	NMeFOSAA (ng/L)	PFBS (ng/L)	PFDA (ng/L)	PFDoA (ng/L)	PFHpA (ng/L)	PFHxA (ng/L)	PFHxS (ng/L)	PFNA (ng/L)	PFTA (ng/L)	PFTTrDA (ng/L)	PFUnA (ng/L)		
Main Basin - Amador Subbasin																							
Pleasanton Well 5 (3S/1E 16L 5)	149	650	2019-05-22	31	4.2	-	-	-	-	-	-	-	-	-	-	-	-	-	-	-	-		
			2019-06-18	31	4.1	-	-	-	-	-	-	-	-	-	-	-	-	-	-	-	-	-	
			2019-12-03	21	3.3	ND	ND	ND	ND	ND	ND	ND	ND	4.7	ND	ND	2.2	3.9	19	ND	ND	ND	ND
Pleasanton Well 6 (3S/1E 16L 7)	165	647	2019-05-22	30	4.1	-	-	-	-	-	-	-	-	-	-	-	-	-	-	-	-		
			2019-06-18	22	3.5	-	-	-	-	-	-	-	-	-	-	-	-	-	-	-	-	-	
			2019-12-03	22	3.6	ND	ND	ND	ND	ND	ND	ND	ND	5	ND	ND	2.5	4.5	23	ND	ND	ND	ND
			2020	22	5.6	ND	ND	ND	ND	ND	ND	ND	ND	5.6	ND	ND	2.5	5.1	23	ND	ND	ND	ND
Pleasanton Well 8 (3S/1E 16A 2)	200	495	2019-05-22	120	9.2	-	-	-	-	-	-	-	-	-	-	-	-	-	-	-	-		
			2019-06-18	110	8.3	-	-	-	-	-	-	-	-	-	-	-	-	-	-	-	-	-	
			2019-12-03	69	7.5	ND	ND	ND	ND	ND	ND	ND	ND	7.5	ND	ND	8.1	12	60	4	ND	ND	ND
			2020	110	8.3	ND	ND	ND	ND	ND	ND	ND	ND	7.9	ND	ND	7.6	13	65	4.5	ND	ND	ND
Main Basin - Bernal Subbasin																							
Hopyard 6 (3S/1E 17D12)	235	310	2018-11-28	ND	ND	-	-	-	-	ND	ND	ND	ND	ND	ND	ND	ND	ND	ND	ND	ND		
			2019-07-08	ND	ND	ND	ND	ND	ND	ND	ND	ND	ND	ND	ND	ND	ND	ND	ND	ND	ND	ND	
Hopyard 9 (3S/1E 18A 6)	158	490	2019-01-02	ND	ND	-	-	-	-	ND	ND	ND	ND	ND	ND	ND	ND	ND	ND	ND	ND		
			2019-07-08	ND	ND	ND	ND	ND	ND	ND	ND	ND	ND	ND	ND	ND	ND	ND	ND	ND	ND	ND	
Main Basin - Mocho II Subbasin																							
CWS Well 19 (3S/2E 8G 1)	120	455	2019-04-04	19	4.5	-	-	-	-	-	-	-	-	-	-	-	-	-	-	-	-		
			2020	21	5.8	ND	ND	ND	ND	ND	ND	ND	ND	4.5	ND	ND	ND	4.7	9.9	ND	ND	ND	ND

Notes:

Bold PFOS and PFOA concentrations indicate notification level exceedance (6.5 ng/L and 5.1 ng/L, respectively)

Bold red PFOS and PFOA concentrations indicate response level exceedance (40 ng/L and 10 ng/L, respectively)

- = result for this compound was not reported

ft bgs = feet below ground surface

ND = analyte not detected above the reporting limit

ng/L = nanograms per liter

Table 2. PFAS Results for Monitoring and Domestic Wells

PFAS Potential Source Investigation, Zone 7 Water Agency

Well Name	Display Name	Well Type	Total Depth (ft bgs)	Top of screen (ft bgs)	Bottom of screen (ft bgs)	Aquifer	Sample Date	PFOS (ng/L)	PFOA (ng/L)	11CI-PF3OUdS (ng/L)	9CI-PF3ONS (ng/L)	ADONA (ng/L)	HFPO-DA (ng/L)	NEtFOSAA (ng/L)	NMeFOSAA (ng/L)	PFBS (ng/L)	PFDA (ng/L)	PFDoA (ng/L)	PFHpA (ng/L)	PFHxA (ng/L)	PFHxS (ng/L)	PFNA (ng/L)	PFTA (ng/L)	PFTTrDA (ng/L)	PFUnA (ng/L)	
Main Basin - Amador Subbasin																										
3S/1E 1P 2	1P2	Monitoring	50	40	45	Upper	2019-09-16	26	ND	ND	ND	ND	ND	ND	ND	8.4	ND	ND	ND	ND	13	ND	ND	ND	ND	
3S/1E 2N 6	2N 6	Monitoring	55	40	55	Upper	2019-09-16	47	7.3	ND	ND	ND	ND	ND	ND	10	ND	ND	ND	ND	16	3.3	ND	ND	ND	
3S/1E 2Q 1	2Q 1	Monitoring	45	35	45	Upper	2019-10-15	37	4.7	ND	ND	ND	ND	ND	ND	13	ND	ND	ND	2	22	ND	ND	ND	ND	
3S/1E 2R 1	2R 1	Monitoring	33	21	26	Upper	2019-09-16	55	17	ND	ND	ND	ND	ND	ND	15	ND	ND	2.8	7.6	10	4.1	ND	ND	ND	
3S/1E 8H 9	8H 9	Nested	240	210	230	Lower	2019-06-03	20	5.1	ND	ND	ND	ND	ND	ND	6.3	ND	ND	2.1	5.2	21	ND	ND	ND	ND	
3S/1E 8H10	8H10		440	290	430	Lower	2019-06-03	13	3.5	ND	ND	ND	ND	ND	ND	7.6	ND	ND	2	5	19	ND	ND	ND	ND	
3S/1E 8H11	8H11	Nested	720	520	720	Deep	2019-06-03	20	4.7	ND	ND	ND	ND	ND	ND	7.4	ND	ND	2.5	6.1	24	ND	ND	ND	ND	
3S/1E 9J 7	9J 7		2	120	140	Upper	2019-06-03	26	4.4	ND	ND	ND	ND	ND	ND	5.5	ND	ND	ND	3	18	ND	ND	ND	ND	
3S/1E 9J 8	9J 8		305	280	300	Lower	2019-06-03	60	6.8	ND	ND	ND	ND	ND	ND	12	ND	ND	2.9	9.7	54	ND	ND	ND	ND	
3S/1E 9J 9	9J 9	Monitoring	505	480	500	Lower	2019-06-03	7	ND	ND	ND	ND	ND	ND	ND	ND	ND	ND	ND	4.9	ND	ND	ND	ND	ND	
3S/1E 9P 5	9P 5		105	95	100	Upper	2019-06-03	29	3.9	ND	ND	ND	ND	ND	ND	5.7	ND	ND	ND	4.8	17	ND	ND	ND	ND	
3S/1E 9P 9	9P 9		210	185	205	Lower	2019-06-03	46	4.6	ND	ND	ND	ND	ND	ND	7.1	ND	ND	ND	5.2	28	ND	ND	ND	ND	
3S/1E 9P10	9P10	Nested	310	285	305	Lower	2019-06-03	19	2.1	ND	ND	ND	ND	ND	ND	5.6	ND	ND	2.1	4.2	22	ND	ND	ND	ND	
3S/1E 9P11	9P11		425	405	420	Lower	2019-06-03	3.1	ND	ND	ND	ND	ND	ND	ND	ND	ND	ND	ND	ND	ND	ND	ND	ND	ND	
3S/1E 10A 2	10A 2	Monitoring	88	70	80	Upper	2019-10-01	450	13	ND	ND	ND	ND	ND	ND	25	ND	ND	4.1	18	120	ND	ND	ND	ND	
3S/1E 10B 8	10B 8	Nested	200	100	190	Lower	2019-05-29	1200	-	-	-	-	-	-	-	-	-	-	-	-	-	-	-	-	-	
			2019-09-17	1000	36	ND	ND	ND	ND	ND	ND	ND	ND	ND	ND	79	ND	ND	19	74	550	ND	ND	ND	ND	
3S/1E 10B 9	10B 9		294	244	284	Lower	2019-05-29	45	-	-	-	-	-	-	-	-	-	-	-	-	-	-	-	-	-	
			2019-09-17	120	7.4	ND	ND	ND	ND	ND	ND	ND	ND	ND	ND	15	ND	ND	4.5	19	120	ND	ND	ND	ND	
3S/1E 10B10	10B10	Nested	600	400	590	Lower	2019-09-17	240	-	-	-	-	-	-	-	-	-	-	-	-	-	-	-	-		
			2019-09-17	16	ND	ND	ND	ND	ND	ND	ND	ND	ND	ND	ND	ND	ND	ND	ND	ND	ND	9.3	ND	ND	ND	ND
3S/1E 10B11	10B11	Nested	810	660	800	Deep	2019-09-17	32	-	-	-	-	-	-	-	-	-	-	-	-	-	-	-	-		
			2019-09-17	32	2.5	ND	ND	ND	ND	ND	ND	ND	ND	ND	ND	4.2	ND	ND	ND	5	35	ND	ND	ND	ND	
3S/1E 10D 2	10D 2	Nested	212	182	212	Lower	2019-09-17	ND	ND	ND	ND	ND	ND	ND	ND	ND	ND	ND	ND	ND	ND	ND	ND	ND	ND	
3S/1E 10D 3	10D 3		322	262	312	Lower	2019-09-17	150	7.7	ND	ND	ND	ND	ND	ND	15	ND	ND	4.5	17	110	ND	ND	ND	ND	
3S/1E 10D 4	10D 4		616	366	606	Lower	2019-09-17	2.3	ND	ND	ND	ND	ND	ND	ND	ND	ND	ND	ND	ND	ND	ND	ND	ND	ND	
3S/1E 10D 5	10D 5		790	710	780	Deep	2019-09-17	ND	ND	ND	ND	ND	ND	ND	ND	ND	ND	ND	ND	ND	ND	ND	ND	ND	ND	
3S/1E 11C 3	11C 3	Monitoring	55	35	55	Upper	2019-10-15	360	19	ND	ND	ND	ND	ND	ND	30	ND	ND	7.4	28	130	2.8	ND	ND	ND	
3S/1E 11G 1	11G 1	Nested	120	100	110	Upper	2019-05-29	200	-	-	-	-	-	-	-	-	-	-	-	-	-	-	-	-		
			2019-10-01	210	16	ND	ND	ND	ND	ND	ND	ND	ND	ND	ND	25	ND	ND	8.3	24	87	ND	ND	ND	ND	
3S/1E 11G 2	11G 2		350	230	340	Lower	2019-05-29	180	-	-	-	-	-	-	-	-	-	-	-	-	-	-	-	-		
			2019-10-01	160	14	ND	ND	ND	ND	ND	ND	ND	ND	ND	ND	26	ND	ND	7.7	23	98	ND	ND	ND	ND	
3S/1E 11G 3	11G 3	Nested	590	380	580	Lower	2019-05-29	11	-	-	-	-	-	-	-	-	-	-	-	-	-	-	-	-		
			2019-10-01	26	ND	ND	ND	ND	ND	ND	ND	ND	ND	ND	ND	ND	ND	ND	ND	ND	2.6	ND	ND	ND	ND	
3S/1E 11G 4	11G 4	Nested	790	620	780	Deep	2019-05-29	170	-	-	-	-	-	-	-	-	-	-	-	-	-	-	-	-		
			2019-10-01	170	14	ND	ND	ND	ND	ND	ND	ND	ND	ND	ND	25	ND	ND	7.5	23	93	ND	ND	ND	ND	
3S/1E 12A 2	12A 2	Monitoring	69	64	69	Upper	2019-10-15	100	19	ND	ND	ND	ND	ND	ND	15	ND	ND	11	20	52	ND	ND	ND	ND	
3S/1E 12D 2	12D 2	Monitoring	45	36	41	Upper	2019-10-15	100	12	ND	ND	ND	ND	ND	ND	8.5	ND	ND	14	36	76	ND	ND	ND	ND	
3S/1E 12G 1	12G 1	Monitoring	73	63	68	Upper	2019-10-01	68	15	ND	ND	ND	ND	ND	ND	7.1	ND	ND	4.7	10	12	2	ND	ND	ND	
3S/1E 12H 4	12H 4	Nested	270	185	260	Lower	2019-09-30	5.3	ND	ND	ND	ND	ND	ND	ND	ND	ND	ND	ND	ND	ND	3.1	ND	ND	ND	
3S/1E 12H 5	12H 5		400	360	390	Lower	2019-09-30	8.4	ND	ND	ND	ND	ND	ND	ND	ND	ND	ND	ND	ND	ND	ND	ND	ND	ND	
3S/1E 12H 6	12H 6		480	410	468	Lower	2019-09-30	ND	ND	ND	ND	ND	ND	ND	ND	ND	ND	ND	ND	ND	ND	ND	ND	ND	ND	
3S/1E 12H 7	12H 7		684	609	674	Deep	2019-09-30	ND	ND	ND	ND	ND	ND	ND	ND	ND	ND	ND	ND	ND	ND	ND	ND	ND	ND	
3S/1E 12K 2	12K 2	Nested	300	210	295	Lower	2019-09-30	6.9	3.3	ND	ND	ND	ND	ND	ND	2.6	ND	ND	ND	2	3.1	ND	ND	ND	ND	
3S/1E 12K 3	12K 3		475	355	470	Lower	2019-09-30	ND	ND	ND	ND	ND	ND	ND	ND	ND	ND	ND	ND	ND	ND	ND	ND	ND	ND	
3S/1E 12K 4	12K 4		575	550	570	Deep	2019-09-30	ND	ND	ND	ND	ND	ND	ND	ND	ND	ND	ND	ND	ND	ND	ND	ND	ND	ND	
3S/1E 16A 4	16A 4	Monitoring	603	260	580	Lower	2019-06-05	38	-	-	-	-	-	-	-	-	-	-	-	-	-	-	-	-		
		2019-10-02	37	3.3	ND	ND	ND	ND	ND	ND	ND	ND	ND	ND	6.6	ND	ND	2.9	6.7	34	ND	ND	ND	ND		
3S/1E 16C 2	16C 2	Nested	190	165	185	Lower	2020-03-04	9.6	ND	ND	ND	ND	ND	ND	ND	ND	ND	ND	ND	ND	8.1	ND	ND	ND	ND	
3S/1E 16C 3	16C 3		305	280	300	Lower	2020-03-04	9.9	ND	ND	ND	ND	ND	ND	ND	4.3	ND	ND	ND	2.3	15	ND	ND	ND	ND	
3S/1E 16C 4	16C 4		375	355	370	Lower	2020-03-04	8.6	ND	ND	ND	ND	ND	ND	ND	4.2	ND	ND	ND	2.3	15	ND	ND	ND	ND	
3S/2E 19D 7	19D 7	Nested	180	100	180	Upper	2020-02-13	ND	ND	ND	ND	ND	ND	ND	ND	ND	ND	ND	ND	ND	ND	ND	ND	ND		
3S/2E 19D 8	19D 8		260	210	260	Lower	2020-02-13	2.9	ND	ND	ND	ND	ND	ND	ND	ND	ND	ND	ND	ND	ND	ND	ND	ND		
3S/2E 19D 9	19D 9		390	280	390	Lower	2020-02-13	13	3.3	ND	ND	ND	ND	ND	ND	ND	ND	ND	ND	4.2	2.8	ND	ND	ND	ND	
3S/2E 19D10	19D10		470	420	470	Lower	2020-02-13	10	7.1	ND	ND	ND	ND	ND	ND	3.2	ND	ND	3.6	9	4.4	ND	ND	ND	ND	

Table 2. PFAS Results for Monitoring and Domestic Wells

PFAS Potential Source Investigation, Zone 7 Water Agency

Well Name	Display Name	Well Type	Total Depth (ft bgs)	Top of screen (ft bgs)	Bottom of screen (ft bgs)	Aquifer	Sample Date	PFOS (ng/L)	PFOA (ng/L)	11CI-PF3OUdS (ng/L)	9CI-PF3ONS (ng/L)	ADONA (ng/L)	HFPO-DA (ng/L)	NEtFOSAA (ng/L)	NMeFOSAA (ng/L)	PFBS (ng/L)	PFDA (ng/L)	PFDoA (ng/L)	PFHpA (ng/L)	PFHxA (ng/L)	PFHxS (ng/L)	PFNA (ng/L)	PFTA (ng/L)	PFTTrDA (ng/L)	PFUnA (ng/L)	
Main Basin - Bernal Subbasin																										
3S/1E 18E 4	18E 4	Monitoring	83	69	79	Upper	2019-10-02	ND	ND	ND	ND	ND	ND	ND	ND	ND	ND	ND	ND	ND	ND	ND	ND	ND	ND	ND
3S/1E 18J 2	18J 2	Monitoring	71	61	66	Upper	2019-10-02	3.4	ND	ND	ND	ND	ND	ND	ND	ND	ND	ND	ND	ND	ND	ND	ND	ND	ND	ND
3S/1E 19C 4	19C 4	Monitoring	78	68	73	Upper	2019-10-02	6.9	ND	ND	ND	ND	ND	ND	ND	2.2	ND	ND	ND	ND	2.7	ND	ND	ND	ND	ND
Main Basin - Camp Subbasin																										
3S/1E 2J 3	2J 3	Monitoring	65	55	65	Upper	2019-09-16	9.3	8	ND	ND	ND	ND	ND	ND	ND	ND	ND	8.6	30	3.6	ND	ND	ND	ND	ND
3S/1E 2M 3	2M 3	Monitoring	50	35	50	Upper	2020-03-05	ND	ND	ND	ND	ND	ND	ND	ND	2.2	ND	ND	ND	ND	3.4	ND	ND	ND	ND	ND
3S/1E 3G 2	3G 2	Monitoring	50	40	45	Upper	2020-03-04	ND	ND	ND	ND	ND	ND	ND	ND	2.5	ND	ND	ND	ND	7.4	ND	ND	ND	ND	ND
3S/1E 4A 1	4A 1	Monitoring	50	29.5	49.5	Upper	2020-03-05	16	8.5	ND	ND	ND	ND	ND	ND	8.8	ND	ND	4.6	10	23	ND	ND	ND	ND	ND
3S/1E 4J 5	4J 5	Monitoring	47	22	47	Upper	2020-03-04	40	ND	ND	ND	ND	ND	ND	ND	22	ND	ND	ND	ND	21	ND	ND	ND	ND	ND
3S/1E 4J 6	4J 6	Monitoring	110	68	110	Upper	2020-03-04	ND	ND	ND	ND	ND	ND	ND	ND	ND	ND	ND	ND	ND	ND	ND	ND	ND	ND	ND
3S/1E 2P 3	2P 3	Domestic	380	340	372	Lower	2019-09-16	ND	ND	ND	ND	ND	ND	ND	ND	ND	ND	ND	ND	ND	ND	ND	ND	ND	ND	ND

Notes:

Bold PFOS and PFOA concentrations indicate notification level exceedance (6.5 ng/L and 5.1 ng/L, respectively)

Bold red PFOS and PFOA concentrations indicate response level exceedance (40 ng/L and 10 ng/L, respectively)

- = result for this compound was not reported

ft bgs = feet below ground surface

ND = analyte not detected above the reporting limit

ng/L = nanograms per liter

Table 3. Summary of PFAS Sampling, Results, and Exceedances of Regulatory Limits

PFAS Potential Source Investigation, Zone 7 Water Agency

PFAS Compound	Regulatory Limit (ng/L)		Municipal Wells						Monitoring and Domestic Wells					
	NL	RL	Wells Sampled	Wells Detected	Wells Greater than NL	Wells Greater than RL	Max Conc. (ng/L)	Max Location	Wells Sampled	Wells Detected	Wells Greater than NL	Wells Greater than RL	Max Conc. (ng/L)	Max Location
PFOS	6.5	40	14	12	12	7	120	P8	56	44	40	17	1200	10B8
PFOA	5.1	10	14	12	5	0	9.8	M1	56	29	18	10	36	10B8
11Cl-PF3OUdS	-	-	14	0	-	-	ND	-	56	0	-	-	ND	-
9Cl-PF3ONS	-	-	14	0	-	-	ND	-	56	0	-	-	ND	-
ADONA	-	-	14	0	-	-	ND	-	56	0	-	-	ND	-
HFPO-DA	-	-	14	0	-	-	ND	-	56	0	-	-	ND	-
NEtFOSAA	-	-	14	0	-	-	ND	-	56	0	-	-	ND	-
NMeFOSAA	-	-	14	0	-	-	ND	-	56	0	-	-	ND	-
PFBS	-	-	14	10	-	-	16	M1	56	33	-	-	79	10B8
PFDA	-	-	14	0	-	-	ND	-	56	0	-	-	ND	-
PFDoA	-	-	14	0	-	-	ND	-	56	0	-	-	ND	-
PFHpA	-	-	14	7	-	-	8.1	P8	56	21	-	-	19	10B8
PFHxA	-	-	14	12	-	-	14	M1	56	30	-	-	74	10B8
PFHxS	-	-	14	12	-	-	90	M1	56	40	-	-	550	10B8
PFNA	-	-	14	1	-	-	4.5	P8	56	4	-	-	4.1	2R1
PFTA	-	-	14	0	-	-	ND	-	56	0	-	-	ND	-
PFTrDA	-	-	14	0	-	-	ND	-	56	0	-	-	ND	-
PFUnA	-	-	14	0	-	-	ND	-	56	0	-	-	ND	-

Notes:

ND = analyte not detected above the reporting limit

ng/L = nanograms per liter

NL = notification level

RL = response level

3. Evaluation of Potential PFAS Sources

The objective of this task was to document possible sources of PFAS in Zone 7's service area based on desktop review of property usage and state and federal agency reporting systems. Locations of possible source areas were compared to water supply well locations and the distribution of PFAS in groundwater. Recommendations for additional data collection efforts were made based on the likelihood of a release and proximity to impacted wells.

3.1 PFAS Background

PFAS are a large class of anthropogenic chemicals characterized by carbon chains of varying lengths containing carbon-fluorine bonds. PFAS were first developed in the laboratory in the 1930s and have been manufactured and used in a variety of industries since the 1940s. Widespread use began in the mid-1960s. PFAS have been identified by the U.S. Environmental Protection Agency (EPA) as "contaminants of emerging concern," because analytical methodology, toxicological information, and regulatory standards for these compounds are still evolving (EPA, 2019). As of May 2020, the PFAS master list maintained by EPA includes 5,264 compounds.

PFAS are heat-resistant and can repel oil, grease, and water. As a result, these compounds have been used in many household and industrial applications, including firefighting foam, fabric and fiber stain-protectants, food packaging, paper coatings, specialty paints, waxes, chromium plating mist suppressants, pesticides, and production of nonstick cookware (EPA, 2019).

Use of PFAS in firefighting foam has resulted in significant releases of PFAS to the environment relative to other potential PFAS sources. Fluorine-containing firefighting foams were first tested in the 1960s by the 3M Corporation (3M), which created these foams using a process called "electrochemical fluorination." Because of their superior efficacy in extinguishing Class B (flammable liquid) fires, the 3M aqueous film-forming foam (AFFF or "A-triple-F," sold under the brand name, "Lightwater") was in widespread use in the 1970s. Other companies began manufacturing fluorine-containing firefighting foams following the release of the 3M product. These foams were manufactured using fluorotelomerization, resulting in a different chemical fingerprint than the 3M Lightwater (ITRC, 2018a).

3.1.1 National Level Regulatory Considerations

PFOS and PFOA are two specific PFAS chemicals that are the subject of the current EPA Lifetime Health Advisory levels for drinking water at 70 ng/L (either individually or, if both PFOA and PFOS are detected, as a summed concentration of the two compounds). On February 26, 2020, EPA issued an updated PFAS Action Plan that identifies key steps to address PFAS. Some of the key items included in the EPA Action Plan (EPA, 2020) are as follows:

- Preliminary determination to regulate PFOS and PFOA
- Identification of uses of persistent long-chain PFAS chemicals in surface coatings that cannot be manufactured or imported into the United States without notification and review under the Toxic Substances Control Act
- Updated validated analytical laboratory methods for 11 additional PFAS compounds in drinking water

- Interim recommendations for managing groundwater contaminated with PFOS and PFOA
- Announcement of funding available for new research on managing PFAS in agriculture
- Proposed rulemaking on adding PFAS to the Toxics Release Inventory chemical list
- Directive to prioritize federal research on impacts to agriculture and rural economies

3.1.2 State Level Regulatory Considerations

In August 2019, the DDW established NLs for PFOS at 6.5 ppt and PFOA at 5.1 ppt. NLs are established as precautionary measures for contaminants that may be considered candidates for establishment of maximum contaminant levels (MCLs) but have not yet undergone or completed the regulatory process. In addition to NLs and pursuant to Health and Safety Code Section 116455, in February 2020, DDW lowered the RL from 70 ppt for the combined concentration of PFOS and PFOA to individual RLs at 40 ppt for PFOS and 10 ppt for PFOA, based on a running four-quarter average.

At the request of the DDW, the Office of Environmental Health Hazard Assessment (OEHHA) initiated the development of Public Health Goals (PHGs) for PFOA and PFOS in drinking water. PHGs are concentrations of contaminants in drinking water that pose no significant acute or chronic health risks and are used as the health basis for the development of California's primary drinking water standards (MCLs). Further, under the SWRCB PFAS Investigation, seven additional PFAS chemicals have been detected in multiple wells in California. Therefore, the SWRCB has indicated they are planning to develop NLs for the following seven PFAS compounds:

- PFHxS
- PFBS
- PFHxA
- PFHpA
- PFNA
- PFDA
- ADONA

3.2 Desktop Review Process

Possible use locations were identified from web-based review of publicly available information. No interviews with business owners, patrons, or other people of interest were conducted. Material inventories were not requested or reviewed. Possible PFAS use areas are therefore not definitive evidence that a release of PFAS occurred at these addresses, unless otherwise noted in this document. This search included the 23-square-mile (3.9 miles by 5.9 miles) area shown on Figure 6. Additionally, while property usage was confirmed using Google Earth imagery and website reviews, it is acknowledged these images and digital files may not have been up to date at the time of the review.

3.2.1 Web-Based Search

A web-based search for sites likely to be sources of PFAS was conducted using an internet search engine (Google) and mapping tool (Google maps). Parcel locations were recorded if evidence of the following property uses was identified:

- Airports
- Fires extinguished with Class B AFFF or alcohol-resistant foam, including car and vehicle crash locations where fires occurred
- Fire stations and fire engine maintenance areas
- Fire training areas
- AFFF spray areas
- Military installations
- Chromium plating shops
- Spills of fluorinated dielectric fluids from transformers
- Car washes, auto body shops, and vehicle detailing shops
- Fire protection system installation companies
- Pesticide manufacturing or application
- Countertop manufacturing and coating
- Outerwear and shoe manufacturing
- Tank farms and other facilities with possible foam fire suppression systems
- Carpet and upholstery manufacturing and stain resistant treatment facilities
- Manufacturing of food packaging, coated paper, and cookware

In addition to these potential direct PFAS sources, landfills, recycled water for irrigation, and biosolids application sites are also included in the search. These entities do not generate PFAS waste but may receive PFAS-containing wastewater or refuse and convey them into the environment.

3.2.2 Environmental Data Resources Report Evaluation

An Environmental Data Resources (EDR) Report was generated by EDR Inc. to combine information from various regulatory programs (such as the Resource Conservation and Recovery Act; Comprehensive Environmental Response, Compensation, and Liability Act; NPDES; and Emergency Planning and Right-to-Know Act) and databases (EDR, 2020); a copy of the EDR Report is provided in Attachment C. The EDR Report included sites that fell within the boundaries of the Zone 7 service area. The sites listed by EDR were first screened against their relevancy toward PFAS to determine which information required a more detailed review. For example, the information from the Material Licensing Tracking System database, which tracks radioactive materials, was not reviewed in detail because it is not relevant to use of PFAS. Sites that fell within a category that could be linked to PFAS were examined in more detail and an internet search engine was used to determine if the location was still current or had changed name or ownership.

Because this study is focused on current property usage, some information in the EDR Report that may be relevant to PFAS releases, but is associated with former property owner use, was excluded from this TM. This information will be retained in the event a more thorough assessment of individual parcels is determined to be warranted. Attachment D includes database searches that were not reviewed in detail, with explanations describing why the information is not relevant to this study.

3.2.3 Other Websites and Databases

Additionally, the EPA and the SWRCB GeoTracker websites were used to identify information concerning hazardous materials that were potentially stored on, or discharged from, different sites. For the "Spills" database, information was reviewed to determine if the spill report indicated a discharge of a material likely to contain PFAS. Sewage overflows were not reported in this report because they are associated with the presence of a WWTP. The Emergency Response Notification System Database results were screened using an internet search engine to determine if the emergency of interest was a fire of a flammable liquid or gas (where Class B firefighting foam may have been used).

3.3 Potential PFAS Sources Identified in Zone 7 Service Area

The following subsections describe site types typically associated with possible PFAS-containing materials, rationale for their inclusion as potential sources of PFAS in Zone 7 groundwater, and presence of these site types within Zone 7 service area.

3.3.1 Fires and Emergency Response with Possible Use of Class B Firefighting Foams

Different mixtures of anionic, cationic, and nonionic fluorinated surfactants have been patented as AFFF agents that minimize the evaporation of flammable solvents and hydrocarbons from ignition (Kissa, 1994). Because Class B fires are fires that involve flammable liquids and gases, AFFF agents are often used during these incidents. Therefore, locations where these fires have occurred are expected to be PFAS-release areas. While the vast majority of fires caused by vehicular accidents are small in nature, PFAS are known to be persistent in the environment and recurrent release of AFFF agents can lead to long-term accumulation of these chemicals in the environment.

As part of this study, a review of information indicative of possible releases of AFFF during firefighting was completed. Jacobs contacted the fire departments and CalFire directly, but was told the requested information was not readily available to the public and our team was informed that such a request had to be approved by the City's legal department. Jacobs then searched public fire department records, the emergency response notification system, and the California SPILLS and HAZMAT databases to identify fires where Class B firefighting foam or AFFF agents may have been used during emergency response incidents. According to the annual operating report for 2019, the Livermore-Pleasanton Fire Department (LPPFD) responded to 436 fire incidents, of which approximately 80 incidents were associated with vehicle collisions. Annual operating reports from previous years indicate similar activity. Incident reports and spill reports were not available for most of these incidents and it is therefore unclear which incidents required use of AFFF.

However, database searches identified two incidents involving both fuel and firefighting foams. These incidents are listed in Table 4. Locations are shown on Figure 7.

Table 4. Fires and Traffic Emergencies with Possible Use of AFFF
PFAS Potential Source Investigation, Zone 7 Water Agency

Source	Incident Date	Incident Location	Responding Agency	Description Provided in CA SPILLS or CA OES Databases	Likelihood of AFFF or Class B Foam Use
Cal OES	June 21, 2016	Eastbound Interstate 580 Just West of Livermore	LPFD	Collision caused a fire and spill of flammable fluids, and foam was used to control the fire.	High
CA SPILLS	December 15, 2014	Eastbound 580 at El Charro	LPFD	Tractor-trailer caught on fire for unknown reasons. Upon arrival, the Alameda County Fire Department applied foam to extinguish the fire. Diesel fuel from the saddle tanks leaked in an approximate amount of less than 50 gallons. The fuel and foam entered a dirt ditch located alongside the road. No waterways were impacted.	High

Cal OES = California Office of Emergency Services

More detailed interviews with the fire departments may be helpful in confirming or ruling out potential release areas to determine if additional investigation is warranted. This approach has been successful in other source investigation studies and is a practice commonly used during the development of source control programs (Water Environment Federation, 1996). Attachment E of this TM includes a sample questionnaire that can be used to conduct these interviews.

3.3.2 Use of Class B Fire-Fighting Foams at Airports

AFFF and other PFAS-containing Class B firefighting foams (for example, alcohol-resistant foams) are commonly present at airports in hangar fire suppression systems, fuel farm fire suppression systems, and in emergency response vehicles at airports. Releases of AFFF and other PFAS-containing foams can occur due to inadvertent or intentional activation of foam fire suppression systems in response to fires, during training, during fire-truck equipment testing, and during precautionary measures taken to prevent fires (for example, foaming a runway prior to a hard landing to prevent a fire). Therefore, soil and groundwater at airports and associated facilities may be contaminated with a mixture of PFAS consistent with the foam formulations previously used at the facility.

Hydraulic fluids used in aircraft also may be a source of PFAS. In the manufacturing process for aviation hydraulic fluids, a PFOS-related substance or precursor, such as potassium perfluorooctane sulfonate, has been used as an additive to the aviation hydraulic fluids with a content of about or less than 0.1 percent. According to the manufacturers, this formulation helps prevent evaporation, fires, and corrosion (Boeing, 2001).

Releases of foam from different types of fire suppression systems used in hangars can occur when no fire is present due to accidental releases during general operations and maintenance activities. Incidents where foam is released in response to a fire generally occur outside of the hangar space, typically on runways and taxiways where hard landings, crashes, and engine fires are likely to occur.

During the desktop review, the Livermore Municipal Airport was identified within the boundaries of the study area. The following history for the Livermore Municipal Airport is summarized from information on the City of Livermore's Website (City of Livermore, 2020). The original airfield that supported the area was built in 1929 east of the current airport. In 1942, the federal government took over the airfield under condemnation proceedings to use as a Naval Auxiliary Airfield in support of the Livermore Naval Air Station, which was at the location now occupied by the Lawrence Livermore National Laboratory. The Naval Auxiliary Field is discussed in more detail in Section 3.3.5.

Following World War II, the City of Livermore operated the airfield as the Livermore Sky Ranch under a lease with the Navy. In July 1953, the City of Livermore acquired the title for the property from the Navy. The Livermore Municipal Airport, at the current location, was completed and ready for use in 1965 and improvements and expansion continued in the 1970s and 1980s. Currently, the airport covers 590 acres, and includes 392 hangars, 249 tie-downs, 9 shelters, and is home to 580 based aircraft. In calendar year 1999, the Livermore Municipal Airport was the 11th busiest airport in California. Figure 8 shows the current location of the Livermore Municipal Airport and the former location at the Former Navy Auxiliary Airfield.

Figure 8 shows the locations of various facilities at the airport and groundwater wells that have been sampled for PFAS. Important findings regarding airport operations that are of value to the PFAS source investigation are summarized below:

- On November 25, 2013, the City of Livermore approved a long-term lease to Five Rivers Aviation, LLC., which provides both fire suppression system maintenance services and aircraft fueling services to the Livermore Municipal Airport.
- Fuel farm facilities located at the Livermore Airport consisted of three 15,000-gallon underground storage tanks (two containing Avgas and one containing Jet Fuel A), a fuel receiving station, an aboveground storage tank containing diesel fuel, a sump and fuel filter rack, and underground fuel lines to the remote dispenser. The use of the fuel farm facilities was discontinued in April 2019 and replaced by the Five Rivers Aviation fueling facility at 700 Terminal Circle, west of and adjacent to the new Livermore Airport Administration building (BSK, 2020). It is not clear whether the fueling facility is outfitted with a foam fire suppression system.
- Aircraft Logistic Support Company (ALCO) is another facility operating at the Livermore Airport. ALCO is a provider of maintenance, repair, and overhaul services for auxiliary power units and engine-driven compressors, as well as a variety of other critical components for hydraulic, pneumatic, fuel, and electrical systems.
- On March 20, 2019, the SWRCB initiated investigation of PFAS (or materials suspected of containing PFAS) at different airport facilities. However, because the Livermore-Pleasanton airport is a small airport and operations do not require certification under Title 14, Code of Federal Regulations (CFR), Part 139 (14 CFR Part 139), no sampling was required at this facility.

A search of news reports and the HAZMAT, CERS, Cal OES, and CA SPILLS databases (2007 and 2020) was conducted to evaluate potential emergency responses at the airport where AFFF may have been used. The database search did not return any additional information on the nature of the database entries listed in the EDR Report. An internet search of news reports and Federal Aviation Administration (FAA) records indicated plane crashes occurred at or near the airport on the following dates:

- September 20, 2001
- May 29, 2002
- November 25, 2002
- December 23, 2005
- June 16, 2007
- June 21, 2014
- April 5, 2018
- August 21, 2019

Fires were documented as a result of the 2007 and 2014 crashes. It is unclear if fires occurred as a result of any of the other crashes or if any fires were extinguished with AFFF. The Airport Layout Plan Update for the Livermore Municipal Airport identifies LPFD Station 10 as the emergency responder for emergencies at the airport (Coffman Associates, Inc., 2014). Station 10 is located on the north side of the airport and has direct access to the airfield. Since the Livermore Municipal Airport is not a commercial service facility, an onsite fire station is not required and therefore Fire Station 10 may not meet some FAA requirements for an on-airport fire station (Coffman Associates, Inc., 2014). Further, during a telephone conversation on September 19, 2020, with Mr. Aaron Lacey from the LPFD, Mr. Lacey explained that LPFD does not own aircraft rescue and firefighting equipment. If a fire emergency occurred in the past, it is likely the fire department would have responded using fire engines that are set up to use of Class B firefighting foam.

Because AFFF and other PFAS-containing Class B firefighting foams are commonly present at airports in hangars and during emergency response, releases may have occurred. Additional evaluation of potential releases at Livermore Municipal Airport through more thorough interviews or additional sampling is recommended.

3.3.3 Fire Stations, Firefighter Training, and Fire Engine Maintenance Areas

Fire stations can be sources of PFAS to the environment because Class B foams and or AFFF agents are used during equipment testing and training activities, and may be spilled during transfer of Class B foams into fire engines. Eleven fire stations are located within the study area that are part of the LPFD, the Alameda County Fire Department (ACFD), and the U.S. Army Camp Parks (Table 5 and Figure 9). According to the description in the emergency response databases, both the LPFD and ACFD may respond to fire emergencies in the vicinity of the study area. Below is a brief description of these fire departments and facilities of interest. In addition to the 11 fire stations, the EDR Report listed two fire training sites located within the study area.

3.3.3.1 Livermore-Pleasanton Fire Department

Services provided by the LPFD include fire suppression (structures, vehicle, vegetation, trash/rubbish), emergency medical response, hazardous materials incidents, and rescue emergencies.

The following information relating to the LPFD was provided in the draft Environmental Impact Report for the Livermore Airport General Plan Amendment and Rezoning Project (LSA Associates, Inc., 2009). The Livermore and Pleasanton Fire Departments were consolidated through a joint powers authority in 1996 to better serve the two communities. The LPFD operates 10 fire stations in its system. In 2008, the LPFD responded to 10,798 fire and emergency calls, including 18 calls to the Livermore Municipal Airport. The Livermore Municipal Airport is served by Fire Station 10. If an emergency call were to require additional units, the Livermore Municipal Airport could also be served by Fire Station 7 and Fire Station 3.

The LPFD Training Center is located at 3301 Busch Road in Pleasanton. After conducting a search in the reference databases, no information on potential fire foam spills was reported. However, during conversations with the operations manager from LPFD, we learned that most, if not all, training activities are conducted at the LPFD Training Center for members of the fire department. These training activities include fires involving flammable fluids and vehicle fires. The operations manager confirmed that Class B foam has been used for these training modules at the LPFD Training Center.

3.3.3.2 Alameda County Fire Department

The ACFD was formed on July 1, 1993, as a special district with the Alameda County Board of Supervisors as its governing body. Since 1993 the following communities have consolidated with the ACFD:

- July 1, 1997: City of Dublin
- October 1, 2007: Lawrence Livermore National Laboratory

In order to understand the extent of AFFF or other PFAS containing firefighting foams with the fire departments, our team contacted staff from the LPFD and ACFD. Telephone conversation summaries are included in Attachment F, and key notes are included in Table 5.

3.3.3.3 Las Positas College Regional Firefighter Academy

Las Positas College at 3000 Campus Hill Drive in Livermore offers a Regional Firefighter Academy (Figure 9). Las Positas College began as an extension center of Chabot College in 1963 and opened its Livermore Campus in 1975 (Las Positas College, 2020). They offer an associate of science degree in fire service technology and are California's first and only Fire and Emergency Services Higher Education recognized degree program. Based on review of the college's website, it is not clear when the Fire Services Technology program was first offered. The Las Positas Firefighting Academy states that training is offered through partnerships with the LPFD and utilizes personnel from fire agencies throughout Alameda County (Las Positas College, 2020).

Table 5. Fire Stations, Fire Training, and Fire Engine Maintenance Areas
PFAS Potential Source Investigation, Zone 7 Water Agency

Site	Operations and Equipment	Use of Fire-Fighting Foam	Location
LFPD Station 1	Located at 3560 Nevada Street in Pleasanton. Station apparatus includes E91, E691, UTV91, B9.	Class A, B, and eco-friendly foams. Use of AFFF discontinued approximately 10 years ago. ^a	Approximately 0.7 mile south of Pleasanton 8.
LFPD Station 3	6,195-square-foot station – originally built in 1969 and then renovated in 1989. Fire Station No. 3 is located at 3200 Santa Rita Road at the northeast corner of West Las Positas Boulevard in Pleasanton. Station apparatus includes T93, E693.	Class A, B, and eco-friendly foams. Use of AFFF discontinued approximately 10 years ago. ^a	Approximately 0.3 mile north of Mocho wellfield.
LFPD Station 7	Located at 951 Rincon in Livermore. Station apparatus includes E97, E697.	Class A, B, and eco-friendly foams. Use of AFFF discontinued approximately 10 years ago. ^a	Approximately 0.3 mile west of CWS19.
LFPD Station 8	Located at 5750 Scenic Avenue in Livermore. Station apparatus includes E98, E698.	Class A, B, and eco-friendly foams. Use of AFFF discontinued approximately 10 years ago. ^a	Outside of project area to the east.
LFPD Station 9	Opened in 2016 to replace the City of Livermore fire station in operation. FS 9 is located at 1919 Cordoba Street Livermore, CA 94550. Station apparatus includes E99, E399.	Class A, B, and eco-friendly foams. Use of AFFF discontinued approximately 10 years ago. ^a	In the southeastern corner of the search area, upgradient of the mining area.
LFPD Station 10	Station apparatus includes E90, E690.	Class A, B, and eco-friendly foams. Use of AFFF discontinued approximately 10 years ago. ^a	On the Livermore Municipal Airport.
ACFD Station 8	This fire station has one Type I engine, one Type III engine and a patrol. Station #8's response area is the largest in the ACFD, encompassing 280 square miles of open range land and freeways. This station is currently out of service.	Class A and B and occasionally AFFF. ^b	On the eastern boundary of the search area, upgradient of the mining area.
ACFD Station 15	The fire station houses the apparatus and equipment for the Reserve Firefighters of the ACFD.	Class A and B and occasionally AFFF. ^b	Outside the search area to the northwest.

Table 5. Fire Stations, Fire Training, and Fire Engine Maintenance Areas
PFAS Potential Source Investigation, Zone 7 Water Agency

Site	Operations and Equipment	Use of Fire-Fighting Foam	Location
ACFD Station 17	This fire station houses an engine and a truck company, one Type 3 engine, and a water rescue boat. Station 17 responds to the west, central core, and easternmost sections of Dublin, which includes residential, commercial, and a major entertainment center. This station became operational October 2003.	Class A and B and occasionally AFFF. ^b	Outside the search area to the northwest.
ACFD Station 18	This station has an engine company, one patrol, and a bulldozer. Its response area covers the easternmost portions of Dublin and it is primarily responsible for residential, high density housing, urban wildland interface areas, and Highway 580. It became operational July 2003.	Class A and B and occasionally AFFF. ^b	On the northern edge of the search area and upgradient of the elevated PFAS in groundwater.
ACFD Station 20	Located in building 323 on the Lawrence Livermore National Laboratory site. The former Station 1 of the Livermore Laboratory Fire Department, this hazardous materials team station houses two crews consisting of eight firefighters, one Type III engine, two Type IV apparatus (patrols), a hazardous materials unit, and an ambulance. Fire Station 20 was expanded in 1990 by the addition of a two-story 10,200-square-foot addition. A renovation of the existing portion of Station 20 was completed in November 1993.	Class A and B and occasionally AFFF. ^b	Outside the project area to the east.
Camp Parks Fire & Emergency Services (F&ES)	Dedicated to protecting the Rugged Professional Soldiers, Families, Civilians, Visitors, and the local community with a specialized all hazards emergency response of highly trained, skilled, and certified Firefighters and Paramedics. Camp Parks F&ES is located at 520 Mitchell Drive in Dublin.	Unknown	Outside the search area to the northwest.

Table 5. Fire Stations, Fire Training, and Fire Engine Maintenance Areas
PFAS Potential Source Investigation, Zone 7 Water Agency

Site	Operations and Equipment	Use of Fire-Fighting Foam	Location
Las Positas College Regional Firefighter Academy	Las Positas College Firefighter Academy is offered through partnerships with the LPPFD.	None ^c	On the northern edge of the search area and upgradient of the elevated PFAS in groundwater.
LPPFD Training Center	The LPPFD Training Center is located at 3301 Busch Road in Pleasanton.	Class A and B, and eco-friendly foams. Use of AFFF discontinued approximately 10 years ago.	Approximately 0.1 mile west of Pleasanton 8.
Regional Vehicle Maintenance Facility	The ACFD Vehicle Maintenance Facility relocated to Dublin from Ashland in August 2014 and is responsible for maintaining the operational readiness of the Department's fleet of apparatus and support vehicles. Performing routine and emergency repairs, safety inspections, preventative maintenance, communications equipment installation, and emergency apparatus outfitting.	Unknown	Outside the search area to west.
Alameda County Bomb Disposal Range	The Explosive Ordnance Disposal (EOD) Squad is a technical and tactical unit trained to identify, render safe, and dispose of improvised hazardous devices, explosive contraband, small arms ammunition, and expired law enforcement chemicals needing replacement. The EOD Squad has been in existence since 1973. The EOD Squad is available to respond to emergencies 24 hours a day, 7 days a week.	Class A and B and occasionally AFFF. ^b	Outside the search area to the northwest.

^a Per telephone conversation with Deputy Chief - Operations on September 19, 2020

^b Per telephone conversation with anonymous staff from Fire Station 18 on September 23, 2020

^c Per telephone conversation with Las Positas College firefighter academy faculty staff on September 21, 2020

Outside the EDR search area, but still in the vicinity of the study area, three additional fire response and training facilities were identified. These are: (1) Alameda County Bomb Disposal Range, (2) Regional Vehicle Maintenance Facility, and (3) Camp Parks F&ES. As noted on the ACFD website, these three facilities operate in partnership with Alameda County.

Our team contacted the Regional Vehicle Maintenance Facility, but staff were not able to provide information over the phone. The contact information for the administration department was provided to our team to request information in writing. The Alameda County Bomb Disposal Range is identified because AFFF could be used during bomb detonations. Consultation with Alameda County is recommended to better understand the likelihood that PFAS-containing firefighting foams could have been used in the past or are currently used today.

3.3.4 Landfills and Solid Waste Disposal Sites

PFAS compounds have a wide variety of uses in household products and industrial processes. Many of these products ultimately make their way into landfills and, as such, landfill leachates commonly contain PFAS (Wei et al., 2019; Lang et al., 2017). Landfills may contaminate the underlying groundwater if the lined landfill was compromised or leaky, or if the landfill is unlined.

Three waste disposal sites were identified in the EDR Report, including one inactive landfill, one inactive incineration/burn dump area, and one active garbage service transfer and processing facility. A summary of these facilities is presented in Table 6; Figure 10 shows the location of these facilities and groundwater wells that have been sampled for PFAS.

Table 6. Landfill and Solids Disposal Sites
PFAS Potential Source Investigation, Zone 7 Water Agency

Site	Description	Type of Waste Received	Municipal Wells Nearby
Old Pleasanton Landfill	Operated from 1950 until 1969, located at 2500 Vineyard Avenue, Pleasanton.	Mixed municipal	On the southern edge of the search area, 1 to 2 miles from municipal wells and regional PFAS plume
Pleasanton Garbage Service Inc	The Pleasanton Transfer Station and Material Recovery Facility are owned and operated by the Pleasanton Garbage Service and have been in operation since 1976.	C&D, Inerts, White Goods, Mixed Municipal	0.4 mile east of Pleasanton 8
Dublin Former Incinerator/Burn Dump Area	Located at north end of Barnett Boulevard. The site was the location of a former military incinerator and incinerator waste. EnviroStor database states that samples were collected and analyzed for total extractable hydrocarbons, VOCs, SVOCs, metals, pH, and dioxins. Based on the results, the only contaminant of concern identified was lead.	Waste materials including burned debris, broken glass, molten glass fragments and ash have been found on the site	Outside of search area to the west., greater than 1 mile from municipal wells

C&D = construction and demolition
SVOC = semivolatile organic compound
VOC = volatile organic compound

3.3.4.1 Pleasanton Garbage Services

The Pleasanton Transfer Station (01-AA-0003), located on a 7.6-acre site at 3110 Busch Road in the City of Pleasanton, is owned and operated by Pleasanton Garbage Service, Inc. (PGS) and has been in operation since 1976. In addition to Pleasanton, the transfer station serves portions of unincorporated Alameda County within a 15-mile radius, including Sunol Valley and Castlewood. The facility accepts residential, commercial, and industrial franchise waste, and public self-haul deliveries and C&D waste. Amador Valley Industries (AVI), a sister company to PGS, serves the City of Dublin. AVI delivers loads of source-separated recyclables and organics to the Pleasanton Transfer Station for consolidation and delivery to processors. All franchised waste handled at the facility is collected by PGS. The Pleasanton Transfer Station has a three-sort system for garbage, recyclables, and organics. Municipal biosolids are not processed at the PGS composting facility. Residual waste is disposed at the Vasco Road Landfill via transfer trailer trucks.

The station is compatible with adjacent zoning and land-uses, which consist of sand and gravel mining and processing, and other industrial and agricultural uses (Alameda County Waste Management Authority, 2020).

3.3.4.2 Old Pleasanton Landfill

The Old Pleasanton Landfill was privately owned and operated from 1950 until 1969. PGS purchased the landfill in 1969 and operated the landfill until it was closed in 1976. The landfill operated as a nonhazardous Class II-2 solid waste disposal site, accepting waste from the City of Pleasanton and the surrounding area. The waste received was approximately 70 percent residential, 25 percent commercial, and 5 percent demolition/construction waste, and included garbage, rubbish, green waste, appliances, and street refuse. Special wastes received included mixed municipal sludge and septage, water softener brine, cheese whey, and rinsed pesticide containers. Junked vehicles, infectious and pathological wastes, liquids, and chemical toilet pumpings were not accepted at the landfill (EBA Engineering, 2020). According to the California Regional Water Quality Control Board (RWQCB), the landfill does not have a liner and was covered with approximately 2 feet of red clay soil following closure (RWQCB, 2002). Groundwater impacts were initially identified at the site in 1998 and included the presence of VOCs and elevated concentrations of inorganic compounds, including total dissolved solids, chloride, electrical conductivity, and nitrate (EBA Engineering, 2020).

As part of the SWRCB PFAS investigation program, on March 20, 2019, the SWRCB issued Order No. WQ 2019-0006-DWQ, which required several landfills throughout the state to conduct a one-time leachate and groundwater assessment of PFAS. The assessment included collection of groundwater and leachate samples for analysis of PFAS compounds. From the waste disposal sites identified in the EDR Report, only the Old Pleasanton Landfill was required to comply with the Order. Therefore, in October 2019, EBA Engineering completed the final report and submitted it to the San Francisco Bay RWQCB.

A copy of the final report is included in Attachment G for reference. Findings of this assessment, as described in the final report by EBA Engineering, were as follows:

- PFAS compounds were detected in downgradient monitoring wells
- No PFAS were detected in the sample collected from upgradient monitoring well.

Groundwater samples were analyzed for a total of 24 PFAS compounds. Nine different compounds were detected in the two downgradient monitoring wells. Table 7 shows the detected PFAS compounds from the investigation. The complete list of analyses and results are included in the EBA Engineering final report (Attachment G). These results show that PFOA concentrations exceed the current drinking water response levels of 10 ppt, while PFOS were reported to be significantly below the California response level of 40 ppt.

Table 7. Old Pleasanton Landfill PFAS Assessment Results
PFAS Potential Source Investigation, Zone 7 Water Agency

Analyte	Response Level (ng/L)	Monitoring Well W-6 (ng/L)	Monitoring Well W-14 (ng/L)
Perfluorobutanoic Acid (PFBA)	NA	23	16
Perfluoropentanoic Acid (PFPeA)	NA	3.7	4.1
Perfluorohexanoic Acid (PFHxA)	NA	3.4	4.8
Perfluoroheptanoic Acid (PFHpA)	NA	4.8	4.6
Perfluorooctanoic Acid (PFOA)	10	37	29
Perfluorobutanesulfonic Acid (PFBS)	NA	8.3	9.2
Perfluoropentanesulfonic Acid (PFPeS)	NA	3.3	3.7
Perfluorohexanesulfonic Acid (PFHxS)	NA	5.8	6.2
Perfluorooctanesulfonic Acid (PFOS)	40	12	7.4

NA = not applicable

3.3.4.3 Dublin Former Incinerator/Burn Dump Area (Santa Rita Jail Parcel)

The investigation and remediation report prepared for the former incinerator dump located in the properties designated as Parcel 16A Digital Drive of Alameda County's Santa Rita Property redevelopment project in Dublin (SCI, 2002) states that this site is situated in a campus office/commercial redevelopment zone in Dublin, California. The soil stratigraphy comprises interbedded alluvial deposits of sandy and silty clays. The shallow groundwater table is situated at a depth of about 15 feet below site grade. Based on initial data from this report, total lead was identified as the target compound of concern. Exposure scenarios involving potential direct contact with the impacted material were designated for consideration when selecting appropriate site screening levels given that the site will be redeveloped for campus office/commercial uses. No potential aquatic receptors were identified in the area and the regional shallow groundwater is not a designated drinking water source.

The 2001 investigation and remediation report also states that the former incinerator was not associated with the former U.S. Naval Hospital that was also located in Dublin. The hospital was located in the vicinity of Santa Rita Road further to the east, and the hospital had its own incinerator used for processing of solid and medical waste.

3.3.5 Military Installations

A number of activities conducted at military installations are associated with the use of PFAS-containing materials. These activities include, but are not limited to, firefighting and firefighting training; vehicle and aircraft maintenance; disposal of paints, pesticides, and greases; wastewater treatment; and irrigation with recycled water. Because military installations fall under multiple categories in this report, they were combined into one category to minimize redundancy. Three military facilities were identified in the EDR Report near the study area. Facility descriptions are summarized below; locations are shown on Figure 11.

3.3.5.1 Livermore Navy Auxiliary Field

In 1942, the Navy acquired the Former Livermore Navy Auxiliary Field through condemnation against the owners of the private airfield to support activities at the Livermore Naval Air Station located to the east at the site of the current Lawrence Livermore National Laboratory (City of Livermore, 2020). The site of the former Livermore Naval Air Station is currently occupied by Lawrence Livermore National Laboratory. DTSC file review records indicate the operations consisted of Navy pilot touch-and-go landings at the site until 1945 at the end of World War II (DTSC, 2014). The file review also indicated there was no routine onsite servicing or maintenance of aircrafts; however, the site may contain military munitions and explosives of concern. The Navy ceased operations in 1946 and Alameda County took over the land in a lease in 1947 (DTSC, 2014). Federal operations were discontinued prior to commercialization of AFFF agents, and therefore Navy operations are not considered to be a source of fluorinated surfactants to the environment. In 2015, DTSC concurred with the No Department of Defense Actions Indicated submitted by the U.S. Army Corps of Engineers for the Livermore Navy Auxiliary Field (DTSC, 2015). After the property was leased to Alameda County, the City of Livermore operated an airport at this location until 1965 when the Livermore Municipal Airport was opened at its current location to the west (City of Livermore, 2020). The city operations at this location extended only briefly after commercialization of AFFF agents, so there is a small time period where PFAS could have been released to the environment at this location. However, there is no information indicating use of AFFF at the site. The site is currently occupied primarily by residential structures.

3.3.5.2 Camp Parks Military Reservation

Camp Parks Military Reservation (also known as Parks Reserve Forces Training Area [PRFTA]) is a 2,478-acre installation located in Dublin, California and home to the Army's 91st Division. As a component of the Army's Combat Support Training Center, Camp Parks serves as a training area for an estimated 250 reserve component units and 20,000 reservists in northern California. It was constructed during World War II and established in 1942 to support the Naval Mobile Construction Battalion (U.S. Army Environmental Command, 2016). After World War II, the Navy disestablished the site and it was leased to Alameda County until it was reacquired by the U.S. Air Force in 1953. In 1958, the U.S. Air Force excessed the installation and portions of the site were used by the U.S. Navy Radiological Defense Laboratory for experiments conducted on plants and animals. From 1959 to 1973, the Army occupied the site in standby status. In 1973, the installation was reactivated and until present has supported reserve components (U.S. Army Environmental Command, 2016).

The following summary is based on review of the fiscal year (FY) 2016 Installation Action Plan (U.S. Army Environmental Command, 2016). Camp Parks Military Reservation includes seven Installation

and Restoration Program (IRP) sites (five are closed), seven Military Munitions Response Program (MMRP) sites (six are closed), and six Compliance Restoration (CR) sites (four are closed).

- IRP sites include a hazardous waste accumulation area, fire training area, aboveground and underground storage tanks sites, landfills and disposal areas, incinerators, washrack areas, and suspected release sites. The most widespread contaminants of concern at the IRP sites include dioxins/dibenzofurans, metals, petroleum, oil and lubricants, SVOCs, and VOCs. Open IRP sites include a trash incinerator site and former fuel aboveground storage tanks site.
- MMRP sites include an artillery simulator box, cantonment area, rifle range, mortar range, machine gun range, small arms range, and rifle range. The most widespread contaminants of concern at the MMRP sites include munitions and explosives of concern and munitions constituents. The small arms range MMRP site remains open.
- CR sites include a chemical burn area, disposal piles, disposal trenches, and burn pits. The most widespread contaminants of concern at the CR sites are metals, polychlorinated biphenyls (PCBs), and dioxins/furans. The disposal trenches (a former landfill) and burn pits site, both located in the southeastern portion of the site, are the open CR sites. Information was available on the former burn pits located in the southeastern portion of the site (U.S. Department of the Army, 2016). They were reportedly used in the 1940s and 1950s to dispose of debris and waste material. Soil samples collected during remedial investigation of the site exceeded background or human health screening levels for 28 compounds including metals, dioxins/furans, and polycyclic aromatic hydrocarbons. Concentrations in groundwater exceeded their respective screening levels for arsenic, hexavalent chromium, nitrate, and vanadium. Nitrate was the only analyte detected at a concentration that exceeded regional background levels (U.S. Department of the Army, 2016).

The U.S. Army is the lead agency for investigations on Camp Parks, with DTSC providing regulatory oversight. In addition, there are other open regulatory cases under RWQCB oversight on land south of current Camp Parks boundary that were previously on the installation. Based on review of documents for these cases, there has not been any past or planned groundwater characterization of PFAS at Camp Parks. However, many of the sites related to waste disposal, burn sites, ranges, and the fire training area are consistent with possible activities that could have released PFAS to the environment.

3.3.5.3 Camp Parks Communications Annex

The Camp Parks Communications Annex, which is located within the Camp Parks boundary, was a communications outpost associated with Onizuka Air Force Station in Sunnyvale, California. Onizuka Air Force Station's mission included classified work with military satellite programs. Onizuka Air Force Station was closed in September 2015. Very little information relating to the site is available; however, activities at a communication annex would not typically be expected to result in PFAS contamination.

3.3.6 Chromium Plating Shops

PFAS-containing mist suppressants were introduced to the market in 1954. The intent of these agents was to protect workers through modification of surface tension in chromium plating baths, thereby reducing the likelihood of migration of hexavalent chromium into the air. However, these initial PFAS-containing mist suppressants caused weakness, porosity, and cracking, and were not widely used (Riordan et al., 1998; Paulson et al., 2004). In 1995, EPA released a maximum achievable control technology (MACT)

standard for chromium electroplaters, as required by the Clean Air Act Amendments, which restricted emissions, serving as an impetus for implementation of measures to better control airborne chromium. As a result, new generation PFAS-containing mist suppressants were introduced to the market and did not have the same performance issues associated with the early PFAS-containing mist suppressants (Paulson et al., 2004). Use of PFAS-containing mist suppressants was not required at plating facilities as there are other methods of complying with the Clean Air Act requirements; however, use of PFAS was possible at shops where chromium plating was conducted.

The EDR Report did not return results for any chromium plating shops within the study area. Further, on October 25, 2019, the SWRCB issued Order No. WQ 2019-0045-DWQ, which required more than 200 facilities throughout the state to prepare and submit a work plan for the investigation of possible PFAS contamination. None of the facilities included in the SWRCB order are within the study area or in Zone's 7 service area.

Fluorinated surfactants are also used in a variety of electroplating and electroless plating applications such as copper plating, nickel plating, and electropolishing of gas turbine blades of nickel alloys. Therefore, these activities could also lead to releases of PFAS to the environment. Similarly, fluorinated surfactants that are used in various metal surface treatments to prevent corrosion, reduce mechanical wear, and improve aesthetic appearance of metals (Kissa, 1994), could lead to releases of PFAS. Figure 12 shows the five facilities identified in the EDR Report where metal finishing and metal plating occurred in the study area. Five facilities were identified in the search area, including one west of the mining area in Livermore, one northeast of the airport and upgradient of the high concentrations of PFAS in the Upper Aquifer, and three in the south of the City of Pleasanton municipal wells.

Groth Brothers in Livermore has an open cleanup case with the RWQCB for petroleum-related fuel, oil, and lubricating products. According to the site history provided on GeoTracker, there have been historical uses at the site since 1884 including blacksmith operation, automotive garage, retail, lumber yard, grain warehouse, residences printing, paint shops, and auto dealership (SWRCB, 2020). Vapor mitigation measures are currently being considered for the site. No PFAS data are available. Based on the site history, PFAS compounds could have historically been in use and included in other historical releases.

The 76 Station in Pleasanton has a closed cleanup case with the RWQCB for release of gasoline and waste oil. Soil vapor extraction was implemented to remediate the fuel release and the case was closed in 2016. No PFAS data are available for this site. Currently, there is not an autobody shop at this location where plating activities would be conducted. There is potential that plating took place at the site historically and PFAS could have been released.

None of the other plating facilities in the EDR Report had open cases in the state's EnviroStor or GeoTracker databases.

3.3.7 Biosolids Land Application Sites and Water Reclamation Facilities

Because PFAS compounds have a wide variety of industrial and household uses, they are often present in domestic raw sewage (ITRC, 2018b). Conventional wastewater treatment processes are not designed to remove or destroy PFAS constituents, and consequently recycled water uses and biosolids land application may be a pathway for PFAS to reach the environment. Further, treatment processes such as land-based

unlined facultative lagoons, wetlands, sand drying beds, etc., may also convey PFAS into the underlying groundwater (Hu et al., 2016). In California, regulatory agencies have implemented the WDR program, which seeks to protect groundwater with municipal beneficial use designation. Under this program, WWTPs are required to address potential percolation of untreated or partially treated wastewater into the ground and monitor the water quality conditions in groundwater on a regular basis. Two municipal water reclamation facilities were identified in the study area (Figure 13): the DSRSD WWTP and the LWRP (previously described in Section 2.1.1). Closed/decommissioned facilities (for example, Mayo and Rose Haven) are not tabulated and shown. The locations of wastewater irrigation sites within Zone 7's service area are shown on Figure 13.

On July 9, 2020, the SWRCB issued Order No. WQ 2020-0015-DWQ, which requires more than 250 WWTPs statewide to conduct sampling and analysis of 31 PFAS analytes at the following stages in the treatment process:

- Plant influent
- Plant effluent
- Biosolids
- Groundwater monitoring wells
- Advanced treatment brine

It should be noted that publicly owned treatment works in the San Francisco Bay Region (Region 2) are not included in this PFAS investigative order. Region 2 proposed an alternative plan to conduct a regionwide source investigation through the regional monitoring program and the San Francisco Estuary Institute. Therefore, PFAS data are currently not available for these wastewater reclamation plants.

3.3.8 Spills of Fluorinated Dielectric Fluids from Transformers

Some novel dielectric fluids used in transformers contain PFAS (3M Company, 2019). No spills of novel fluorinated dielectric fluids from transformers were identified during the desktop evaluation.

3.3.9 Cement and Aggregate Manufacturing

Fluorinated surfactants can reduce shrinkage and cracking of cement and are sometimes included in some formulations. Fluorinated surfactants like (Fluorad FC-340) improve primers used for coating cement mortar. Thirteen cement and aggregate sites were identified in the EDR search and are shown on Figure 14. Of those, there are cement batch plants and a pool installation and repair contractor. Two of the cement batch plants, Cemex Ready Mix Pleasanton Plant and Right Away Ready Mix, are located in the mining area. Jacobs understands that these cement batch plants move periodically within the mining area as pits are retired and the active mining operation moves to a new location. An additional cement batch plant is located to the west (currently operating as Pleasanton Ready Mix). Based on review of historical aerial photographs, it appears that a cement plant has operated at this location since the 1980s. The pool installation and repair contractor is located north of the Mocho wellfield.

There are no indications of use or release of PFAS at these locations. Sampling of additional monitoring wells in these areas will assist in determining potential impacts related to past activities at these sites.

3.3.10 Fire Protection System Installation Companies

Because foam fire suppression systems in aircraft hangars and at fuel farms and other facilities with high risk of flammable liquids often use PFAS-containing foams, companies that install these systems may handle and potentially release PFAS-containing foam. A number of fire protection equipment suppliers and system installation companies operate within the study area. However, only two were identified that advertised installation of foam fire suppression systems. Others provide a variety of non-foam fire extinguishers and/or install and inspect sprinkler systems. Companies that advertise foam system installation and may be expected to periodically manage PFAS-containing materials are shown on Figure 15. Additional review of DTSC's EnviroStor and SWRCB's GeoTracker databases did not reveal any leaking underground storage tank, spills, or cleanup cases related to these facilities and neither were permitted with WDRs to discharge wastewater. While PFAS-containing materials could potentially be handled by companies installing fire protection systems, there is no evidence of releases to the environment.

3.3.11 Manufacturing Facilities

PFAS have been documented to be used in the manufacture of circuit boards and as insulation in electrical wires (Kissa, 1994). Hence, facilities that manufacture electronics, precision instruments, and/or semiconductors may be a source of PFAS in the environment. Further, PFAS can be used in metal and glass etching processes to increase the speed of etching, for acid polishing or frosting, as treatments on metal surfaces to reduce corrosion, and as surface treatments for glass to prevent finger prints and fogging (Kissa, 1994).

Forty-four sites that are classified as electronics manufacturers, metal finishing, and composites and semiconductor manufacturing were identified within the study area and are shown on Figure 16. A web-based review of these facilities was performed to determine the potential for activities where PFAS-containing products could be used. The review was focused on the areas within 0.5 mile of a municipal well with a PFOS concentration that has exceeded the RL or a monitoring well where PFOS has been detected at concentrations exceeding 100 ng/L. Facilities within this area consisted of precision machine shops, biotechnology manufacturers, composite manufacturers, and electronics manufacturers. Additional review of DTSC's EnviroStor and SWRCB's GeoTracker databases did not reveal any leaking underground storage tank, spills, or cleanup cases related to these facilities and none were permitted with WDRs to discharge wastewater. While PFAS-containing materials could potentially be used in some of these manufacturing processes, there is no evidence of releases to the environment.

3.3.12 Graphic Imaging and Painting

PFAS have been used in printing inks to improve the wetting properties of water and oil-based inks. Enhanced wettability is essential to print on surfaces such as metals and plastics (Kissa, 1994). PFAS also are used in photography printing processes to reduce static electricity, reduce stickiness, prevent spot formation, and control uniformity (Kissa, 1994). For these reasons, companies that produce signs, flyers, or photography are included as business that may use products containing PFAS.

PFAS may be used in paints and sealants to reduce pigment flotation and improve the wetting and leveling properties. PFAS also may be used in some surface treatments to prevent corrosion (Kissa, 1994). Manufacturing processes that use large volumes of specialized paints or coatings may be using products containing PFAS and are thus reported in this document.

Five graphic imaging companies and one paint manufacturing site were identified within the study area. These sites are shown on Figure 17. The paint manufacturing facility appears to no longer be in business in the area. Additional review of DTSC's EnviroStor and SWRCB's GeoTracker databases did not reveal any leaking underground storage tank, spills, or cleanup cases related to these facilities and none were permitted with WDRs to discharge wastewater. While PFAS-containing materials could potentially be used in printing products, there is no evidence of releases to the environment.

3.3.13 Car Washes, Auto Body Shops, and Vehicle Detailing Shops

Because of their ability to repel oil, grease, and water, PFAS are commonly used in polishes, waxes, cleaners, and coatings that may be applied at auto body shops and/or car washes (ITRC, 2017). A desktop review of online mapping and the EDR Report was completed to identify auto body shops, vehicle detailing shops, and car washes within the study area. These facilities could be sources of PFAS to wastewater treatment facilities if they are connected to public sewers. Automobile repair shops were not catalogued because PFAS-containing products are not likely to be used and hazardous waste controls are presumed to be in place already at repair shops. One hundred and sixty-two auto body shops, car washes, and/or vehicle detailing shops were identified within the study area. Because other, non-fluorinated polishes, waxes, cleaners, coatings, and paints are available and no interviews with business owners were conducted, inclusion in this list is not a definitive indication that each or any of these businesses is a potential PFAS use or release area. Because of the prevalence of other car washes, auto body shops, and vehicle detailing shops located throughout the study area, Figure 18 only shows the car washes and car repair facilities that are located within 1 mile of Zone 7 water supply wells.

3.3.14 Stone Countertop Manufacturing and Storage Facilities

Stone countertop sealants may contain fluoropolymers (Keese, 2020) and consequently may be sources of PFAS, and thus this category was included in the desktop review. No countertop manufacturing and storage and sales facilities were identified within the study area. Manufacturers of commercial kitchens (which typically have metal countertops) and general contractors who install, but do not manufacture or store, countertops were not included in this category.

3.3.15 Tank Farms and Other Areas with Possible Foam Fire Suppression Systems

Tank farms that contain very large volumes of flammable liquids as well as power plants may have PFAS-containing foam fire suppression systems. However, there are other alternatives for fire suppression and therefore the presence of a tank farm or power plant is not a clear indication of presence of a fire suppression system that contains PFAS. A desktop review of aerial photography and the EDR Report was completed and did not identify large tank farms and power plants within the study area.

3.3.16 Carpet and Upholstery Manufacturing/Stain Resistant Treatment Facilities

Scotchguard was invented in 1953 and was introduced to consumers in 1967 (3M Company, 2002). Use of Scotchguard and other PFAS-containing stain protectants for preventing stains on upholstery and carpet has been common for many decades since that time. Carpet and upholstery cleaners often offer stain protection services in conjunction with steam cleaning services (Department of Ecology State of Washington, 2018). Seventy-six carpet and/or upholstery cleaning companies were identified within the study area; however, no carpet manufacturing facilities were identified. It is not anticipated that carpet and upholstery cleaning activities would be a significant source of PFAS to the environment.

3.3.17 Manufacturing of Food Packaging, Coated Paper, and Cookware

PFAS have been used in non-stick cookware, food packaging, and other coated papers where their chemical properties were used to repel oil and grease (Department of Ecology State of Washington, 2018). Two facilities related to food packaging, coated paper, and cookware were identified within the study area; however, the facilities were listed as nongenerators in the EDR Report and do not appear to manufacture goods. Therefore, releases from these types of activities are not considered likely sources of PFAS detected in the area.

4. Summary of Findings and Recommendations

This section presents a summary of the findings from the Potential PFAS Source Investigation performed on behalf of Zone 7. Recommendations for future work to delineate the extent of PFAS in groundwater and more in-depth study of the most probable potential sources are also presented below.

4.1 Summary of Findings

The purpose of the Project was to review existing PFAS results and other hydrogeologic data to evaluate the distribution of PFAS in groundwater and simultaneously identify potential PFAS sources. Based on recent sample analyses, PFAS compounds have been detected in 12 groundwater production wells in Zone 7's service area and have exceeded DDW NLs and RLs for PFOS in 12 and 5 wells, respectively. Currently, Zone 7 has blended groundwater and surface water sources to meet PFAS drinking water standards. The following summarizes the findings of the data review and identification of potential PFAS sources.

4.1.1 Review of Groundwater Conditions and Distribution of PFAS

- **Local Hydrogeology:** The two primary aquifers zones within the Main Basin are the Upper and Lower Aquifers. The two zones are separated by a silty clay aquitard that is presented on the geologic cross-sections included in Attachment A. Zone 7's municipal production wells produce from the Lower Aquifer and are located in the western portion of the Amador Subbasin and in the Bernal Subbasin.
- **Mining Area Activities:** Active gravel and sand mining takes place in the center of the Amador Subbasin. The pits are excavated down into the Upper Aquifer, and in some locations the Lower Aquifer, to recover materials. The active mine pits are dewatered and groundwater that is pumped during dewatering activities is conveyed to a series of nearby clay-lined lakes to settle out fines, and then is pumped to Cope Lake then conveyed to Lake I via a pipeline where it recharges groundwater.

Historically, the mining operations discharged to surface water under an NPDES permit to the Arroyo Mocho and Arroyo Valle.

- **Groundwater Flow Conditions:** Regionally, groundwater flow in the Main Basin is from east to west in both the Upper and Lower Aquifers. At nested well locations, groundwater elevations in the Upper Aquifer are typically higher than in the Lower Aquifer. In the Amador Subbasin near Lakes E and D, where dewatering is taking place, the difference in groundwater elevation between the two aquifers increases, lateral gradients steepen in each aquifer, and groundwater flow is toward the active mine pits. West of the mining area, horizontal and vertical gradients generally decrease in both aquifer units. Groundwater elevations in the Lower Aquifer show a slight mound surrounding Lake I where groundwater from dewatering is recharged, suggesting Lake I is hydraulically connected to the Lower Aquifer.
- **Distribution of PFAS Compounds:** PFAS compounds have been detected in 12 of the 14 municipal wells sampled. The PFOS concentration exceeded the NL in 12 wells, and the RL in 7 wells. A maximum PFOS concentration of 120 ng/L was detected in P8. The PFOA concentration exceeded the NL in five wells and has not exceeded the RL in a municipal well. A maximum PFOA concentration of 9.8 ng/L was detected in M1. There are four municipal wells in the Mocho wellfield with varying depths for the top of the perforated interval. PFOS concentrations are highest in M1 with the shallowest perforated interval, and lowest in M4 with the deepest perforated interval.

Five additional PFAS compounds (PFBS, PFHpA, PFHxA, PFHxS, and PFNA) have been detected in municipal wells. Of these compounds, PFHxS is typically detected at the highest concentrations. These compounds are currently not regulated in drinking water. The maximum concentrations for these five compounds were observed in M1 or P8.

The highest concentrations of PFOS and PFOA in the Upper Aquifer are generally observed in the areas surrounding and downgradient (west and south) of the Livermore Airport. PFOS, PFOA, and other PFAS compounds were typically detected together. Only unregulated PFAS were detected at two locations in the Camp Subbasin; both locations are in areas where treated effluent is applied for irrigation. Concentrations of PFOS and PFOA in the area upgradient (southeast) and downgradient (west) of the lakes are all below RLs.

The highest concentrations of PFOS and most of the wells that exceeded the PFOS RL in the Lower Aquifer were observed downgradient of the Livermore Airport and surrounding Lakes H and I. Wells upgradient (east and south) of the depression of the potentiometric surface surrounding the mining area generally exhibited lower PFAS concentrations. West of the mining area in the Bernal Subbasin, PFAS are not detected in the Lower Aquifer.

Five locations in the Deep Aquifer have been sampled for PFAS. The highest concentrations are observed south of the airport and north of the mining area, where PFOS and PFOA exceeded RLs. Concentrations generally decline downgradient to the west. PFAS were not detected at two locations upgradient (east) of the mining area.

PFOS and PFOA were also detected in samples from Cope Lake, Lake H, and Lake I at concentrations ranging from 26 to 46 ng/L (PFOS) and 4.7 to 7.8 ng/L (PFOA). All of Zone 7's municipal wells with PFAS detections are located near or downgradient of these lakes. PFAS concentrations in many of the impacted municipal wells are comparable to the concentrations observed in Lake I.

- **Vertical Distribution of PFAS Compounds in Nested Wells:** The vertical distribution of PFAS in nested wells could be related to activities in the mining area. Dewatering activities, currently in the eastern portion of the mining area, create large depressions in the potentiometric surfaces near the active pits and have significant influence on groundwater flow direction in the Upper and Lower Aquifers. Lake E is just south of the area where the highest concentrations of PFAS are observed in the Upper Aquifer. Dewatering from this pit could cause vertical migration of PFAS to deeper portions of the aquifer. In addition, this water is clarified and routed to Lake I for recharge. The concentrations of PFOS in Lake I, which exceed response levels, could be receiving a contribution of PFAS due to discharges from mine dewatering. Review of the groundwater elevation contours for the Lower Aquifer show mounding conditions beneath Lake I, suggesting the lake may recharge both the Upper and Lower Aquifers. Historically, dewatering activities have presumably moved throughout the mining area as pits are retired and new pits are developed. These spatial and temporal changes in the lateral and vertical gradients would influence PFAS migration and potentially result in a complex redistribution of PFAS in groundwater.

4.1.2 Potential PFAS Sources

Possible PFAS use locations were identified based on web-based review of publicly available information, including an EDR Report for the 23-square-mile area shown on Figure 6. No formal interviews were conducted; however, telephone calls were placed to fire stations and fire training providers to gather information on potential uses of PFAS-containing materials and training procedures. Materials inventories were not requested or reviewed from any of the potential sources identified. Possible PFAS use areas were evaluated for 17 different types of sites. Figure 19 shows the facilities that were identified within a 0.5-mile radius of municipal wells where PFOS has been detected at concentrations that exceed the RL of 40 ng/L or monitoring wells where PFOS has been detected at concentrations that exceed 100 ng/L. Facilities in this area or upgradient of this area are considered to be more likely sources of PFAS detected in regional groundwater. Below is a summary of each type of site evaluated, the relative ranking as a potential source or contributor of PFAS to regional groundwater, and details on specific facilities that are likely sources or should be prioritized for additional evaluation.

- 1) **Fires and Emergency Response with Possible Use of Class B Firefighting Foams (Medium):** A search of the emergency response notification system, fire incident reports, the Alameda County office of emergency, and through the California SPILLS and HAZMAT databases was conducted to identify fires where Class B firefighting foam or AFFF agents may have been used during emergency incidents. Six incidents were identified in or near the search area. While PFAS-containing foams could have been used to extinguish fuel-related fires and could have been released to the environment, the descriptions for the incidents identified were not indicative of a large-scale release that could be the source of the regional PFAS plume.
- 2) **Use of Class B Firefighting Foams at Airports (High):** The highest concentrations of PFAS detected in the Upper Aquifer are in the area surrounding and downgradient of the Livermore Municipal Airport. The airport has operated in this location since 1965, and prior to that was located on the Former Navy Auxiliary Field 1 mile to the east. Due to the potential for historical releases related to these activities and the proximity to the high PFAS concentrations in shallow groundwater, the airport is considered a potential source.

- 3) **Fire Stations, Firefighter Training, and Fire Engine Maintenance Areas (High):** Staff from the LPPFD and ACFD confirmed the use of Class A and Class B foams, and occasionally AFFF in firefighting activities. LPPFD indicated the use of AFFF during training exercises was discontinued approximately 10 years ago; however, training is conducted at the LPPFD Training Center for fuel-related and vehicle fires, where use of Class B foams is common. The Las Positas College Regional Firefighter Academy is located upgradient of the highest concentrations of PFAS in the Upper Aquifer. Staff indicated that no foams were currently used during training on campus; however, they were uncertain of historical training practices. The sites that represent potential sources and the highest priority sites for additional inquiry include LPPFD Station 3, which is just north of the Mocho wellfield; LPPFD Station 10, located on Livermore Municipal Airport; LPPFD Training Center, just east of Pleasanton 8; and Las Positas College Regional Firefighter Academy.
- 4) **Landfills and Solid Waste Disposal Sites (High):** Three landfills or solid waste disposal sites were identified. The Pleasanton Garbage Service Transfer Station, located east of Pleasanton 8, does not dispose of waste onsite and is not considered a potential source. PFAS have been detected in downgradient monitoring wells at The Old Pleasanton Landfill. The PFAS compounds detected and their relative concentrations suggest the landfill is not the source of PFAS impacting municipal wells; however, there have been releases of PFAS to groundwater near the landfill. The downgradient extent of PFAS-impacted groundwater near the landfill is unknown and warrants additional investigation.
- 5) **Military Installations (High):** Three military installations were identified in or near the search area. The Former Livermore Navy Auxiliary Field is located east of the current airport and was the location of the original public airfield in the City of Livermore. The site was used by the military. Federal operations were discontinued after World War II and prior to commercialization of AFFF agents, and therefore military activities at the site are not considered to be a source of PFAS to the environment. The Camp Parks Military Reservation, which includes the Camp Parks Communication Annex, is located northwest (upgradient) of the search area. There are a number of environmental cleanup sites on Camp Parks, including sites related to waste disposal, burn sites, and fire training areas, which are consistent with activities that could have released PFAS to the environment. Based on review of documents for these cases, there has not been any past or planned groundwater characterization of PFAS at Camp Parks. However, additional sampling in the vicinity of Camp Parks could assist in determining if PFAS may have been released at the site.
- 6) **Chromium Plating Shops (Medium):** Five plating facilities were identified in the search area, including one west of the mining area in Livermore, one northeast of the airport and upgradient of the high concentrations of PFAS in the Upper Aquifer, and three south of the City of Pleasanton municipal wells. Two of these facilities have cleanup cases with the RWQCB; however, the facilities are greater than 0.5 mile from municipal wells where PFOS exceeds the RL or monitoring wells where PFOS is greater than 100 ng/L (Figure 19). Groth Brothers Chevrolet in Livermore has an open cleanup case for petroleum-related fuel, oil, and lubricating products. The 76 Station in Pleasanton has a closed cleanup case for release of gasoline and waste oil. No PFAS data were available for either facility. No information was identified for the other three facilities that indicated releases from these sites. Additional sampling downgradient of these facilities, discussed in Section 4.2, will provide additional information regarding potential releases.
- 7) **Biosolids Land Application Sites and Water Reclamation Facilities (Medium):** The PFAS concentrations observed in the Upper Aquifer do not correlate to typical PFAS concentrations in recycled water, which are typically in the singles to tens of ppt. However, there are large areas in the

Zone 7 service area that are irrigated with recycled water that has not been treated with advanced treatment processes known to remove PFAS, and thus recycled water may be a potential contributing source of PFAS to groundwater. PFAS concentrations have been detected in biosolids generated at WWTPs. Therefore, there is a potential for treated biosolids that are injected in the ground to percolate into the soil and potentially impact groundwater.

- 8) **Spills of Fluorinated Dielectric Fluids from Transformers (Low):** No spills of novel fluorinated dielectric fluids from transformers were identified during the desktop evaluation.
- 9) **Cement and Aggregate Manufacturing (Medium):** Three cement batch plants were identified in the southern portion of the search area, one of which is located within 0.5 mile of Pleasanton 8. There are no documented releases from these facilities; however, due to their location near the mining area where there are ongoing dewatering and recharge activities, additional characterization near these facilities is warranted.
- 10) **Fire Protection System Installation Companies (Medium):** Two facilities that advertised installation of foam fire suppression systems were identified within the study area. While companies that install foam suppression systems could periodically manage PFAS-containing materials, there is no evidence of releases to the environment based on review of GeoTracker and EnviroStor databases.
- 11) **Manufacturing Facilities (Medium):** Forty-four sites classified as electronics manufacturers, metal finishing, composites, and semiconductor manufacturing were identified within the study area. A web-based review was conducted for facilities within a 0.5-mile radius of PFOS RL exceedances in municipal wells and concentrations greater than 100 ng/L in monitoring wells (Figure 19). While some of the manufacturing processes used in these facilities could include use of PFAS-containing materials, there is no evidence of releases to the environment based on review of GeoTracker and EnviroStor databases.
- 12) **Graphic Imaging and Painting (Low):** Five graphic imaging companies and one paint manufacturing site were identified within the study area. Review of EnviroStor and GeoTracker databases did not reveal any cleanup cases related to these facilities and none were permitted with WDRs to discharge wastewater; therefore, these sites are not considered a likely source of PFAS to regional groundwater.
- 13) **Car Washes, Auto Body Shops, and Vehicle Detailing Shops (Low):** Car wash facilities were identified throughout the search area; however, there is no evidence to indicate they are a significant source of PFAS.
- 14) **Stone Countertop Manufacturing and Storage Facilities (Low):** No countertop manufacturing and storage and sales facilities were identified during the desktop evaluation.
- 15) **Tank Farms and Other Areas with Possible Foam Fire Suppression Systems (Low):** No tank farms were identified during the desktop evaluation.
- 16) **Carpet and Upholstery Manufacturing/Stain Resistant Treatment Facilities (Low):** No carpet or upholstery manufacturing facilities were identified during the desktop evaluation.
- 17) **Manufacturing of Food Packaging, Coated Paper, and Cookware (Low):** Two facilities related to food packaging, coated paper, and cookware were identified within the study area; however, the facilities were listed as nongenerators in the EDR Report and do not appear to manufacture goods.

4.2 Recommendations

The following recommendations are offered for additional data collection efforts focused on understanding the nature, extent, fate, and transport of PFAS, and investigating potential sources of PFAS in the Zone 7 study area.

- In the data provided by Zone 7 for this evaluation, PFOS has been detected in approximately 80 percent of the monitoring wells that have been sampled for PFAS. Continued sampling of monitoring wells to better define the spatial and temporal distribution of PFAS in groundwater is recommended. In addition to the wells that have been sampled for PFAS, sampling of additional wells around the perimeter of the highest detections in the Upper Aquifer, in particular the areas upgradient of the airport and mining area, is recommended. Figures 20 and 21 show areas where additional sampling is recommended in the Upper Aquifer and Lower Aquifer, respectively. Table 8 summarizes the objectives of the sampling recommended for each of the areas shown on Figures 20 and 21.
- Sampling of existing monitoring wells is the first step recommended for delineating the lateral and vertical extent of PFAS in groundwater. However, based on the results of this initial sampling, this approach may need to be supplemented by installation of additional monitoring wells. In particular, there are not many existing monitoring wells near the LPFD Training Center. Because of the proximity of this fire training area to Pleasanton 8, where some of the highest concentrations of PFAS compounds have been detected in a municipal well, a comprehensive investigation of groundwater near this facility is recommended.
- Future samples submitted for PFAS analyses should be analyzed using EPA Method 533. A longer list of PFAS compounds is reported for this method as compared to EPA Method 537.1, which has been used for previous samples. Reporting of additional compounds, including fluorotelomer sulfonates, would assist in differentiating potential PFAS sources or retardation and/or precursor conversion pathways.
- In addition to sampling additional monitoring wells, sampling of the water extracted for mine dewatering from individual pits will assist in understanding the distribution of PFAS in the basin and could also present an opportunity to identify interim remediation strategies for addressing PFAS in groundwater prior to recharging in the Chain of Lakes. While mining activities are not considered a potential source of PFAS, dewatering activities are in close proximity to high PFAS concentrations, and lakes that are recharged by mine dewatering contain PFAS.
- Historically, water extracted during dewatering of the mine pits was discharged to the arroyos under NPDES permits. Since the water historically extracted during dewatering could have contained PFAS compounds, it is recommended that additional groundwater sampling be conducted from monitoring wells in the Upper Aquifer along Arroyo Mocho and Arroyo Valle to assess potential impacts from historical mine discharges. Samples in Areas 4 and 5 on Figure 20 will assist in evaluating this potential pathway of PFAS migration.

- Wastewater effluent, which commonly contains PFAS, is used extensively for irrigation in portions of Zone 7's service area. The treated wastewater effluent is provided by DSRSD and LWRP, and their current wastewater treatment processes are not designed for PFAS removal. We recommend working collaboratively with neighboring agencies to determine if land application of treated effluent could be contributing PFAS to groundwater. Analyzing the treated effluent that is used for irrigation throughout the Zone 7 service area for the potential presence of PFAS compounds will assist in evaluating this potential mechanism for PFAS impacts to groundwater. If PFAS compounds are present in the treated effluent, the concentrations and the particular compounds detected should be compared to the compounds that have been typically detected in regional groundwater samples collected to date.
- PFAS compounds were detected in monitoring wells downgradient of the Old Pleasanton Landfill. The PFAS detected and their relative concentrations differ from those observed in municipal wells and in regional groundwater. Sampling additional Upper and Lower Aquifer wells downgradient of the Old Pleasanton Landfill will assist in evaluating the landfill's contribution of PFAS to regional groundwater. Groundwater samples collected from monitoring wells in Area 4 and Area 7 on Figures 20 and 21, respectively, will assist in evaluating potential migration of PFAS from the Old Pleasanton Landfill.
- Zone 7 should start a dialogue with the Army and the lead regulatory agencies for cleanup activities at Camp Parks and request immediate development of a sampling plan to evaluate the potential that the installation has impacted drinking water supply wells.
- Additional outreach to conduct formal interviews or surveys of staff at the Livermore Municipal Airport, local fire departments, and the Las Positas College Regional Firefighter Academy is recommended. Activities should be focused on gathering additional information on historical and current foams used during firefighting and training, equipment testing practices, locations of hangars with foam fire suppression systems, and potential knowledge of other facilities in the area with foam fire suppression systems.

Table 8. Recommended Locations for Additional PFAS Sampling
PFAS Potential Source Investigation, Zone 7 Water Agency

Aquifer Unit (Figure Reference)	Area	Sampling Objectives	Monitoring Wells in Area
Upper Aquifer (Figure 20)	1	Monitoring of PFAS concentrations in the Upper Aquifer upgradient of the Mocho wellfield. Sampling in this area laterally delineates PFAS upgradient of 4A1 and 4J5.	5K6, 33P2, and 33R1
	2	Monitoring of PFAS concentrations in the Upper Aquifer along Arroyo Las Positas in the area downgradient of Las Positas College and upgradient of the Livermore Municipal Airport. Sampling in this area could laterally delineate the upgradient extent of high concentrations of PFAS detected in the Upper Aquifer surrounding the airport.	1F2, 1H3, 1L1, 2J2, 2K2, and 7C2
	3	Monitoring of PFAS concentrations in the Upper Aquifer in the southeastern mining area surrounding the depression observed due to dewatering activities. Sampling in this area is intended to better define the southern extent of PFAS in the Upper Aquifer.	7N2 and 13P5
	4	Monitoring of PFAS concentrations in the Upper Aquifer in the area downgradient of the Old Pleasanton Landfill and in the area surrounding the LPPD Training Center. Sampling in this area would assist in evaluating potential regional impacts due to fire training activities and cement batch plant operations, and would help to evaluate the downgradient extent of impacts from the Old Pleasanton Landfill.	16 E4, 16P5, and 22D2
	5	Monitoring of PFAS concentrations in the Upper Aquifer near the Mocho wellfield. Sampling in the area would assist in evaluating potential releases near the Mocho wellfield and laterally delineating the downgradient extent of PFAS in the Upper Aquifer.	8B1, 8G4, and 8K1
Lower Aquifer (Figure 21)	6	Monitoring of PFAS concentrations in the Lower Aquifer upgradient of the Mocho wellfield. Sampling in this area is intended to provide information related to potential PFAS impacts and to laterally delineate the northern extent of PFAS in the Lower Aquifer.	5K7
	7	Monitoring of PFAS concentrations in the Lower Aquifer throughout the southern portion of the mining area. Sampling in this area is intended to define the southern extent of PFAS and concentrations near City of Pleasanton wells in the Lower Aquifer.	13P6, 13P7, 13P8, 14D2, and 15M3
	8	Monitoring of PFAS concentrations in the lower west area of the impacted City of Pleasanton wellfield. Sampling in this area is intended to define the southwestern extent of PFAS and concentrations in the Lower Aquifer.	20C3, 20C8, and 20C9

5. References

3M Company. 2019. Fluorinert Electronic Liquids. https://www.3m.com/3M/en_US/company-us/all-3m-products/~/All-3M-Products/Chemicals/Chemicals/Fluorinert/Fluorinert-Electronic-Liquids/?N=5002385+8709318+8710710+8711017+8717586+8736409+8745514+3294857497&rt=r3. Accessed December 19, 2019.

3M Company. 2002. *A Century of Innovation, The 3M Story*.

Alameda County Waste Management Authority. 2020. *Alameda County Waste Management Plan (ACWMP) 2020*. Alameda County Waste Management Authority, Oakland, California. March.

Boeing. 2001. "Flashjet[®] Qualification Test Programs Expand Customer Application." *Boeing A&M Environmental Technotes*. Vol 6, No. 1. February. Accessed December 19, 2019. <http://www.boeing.com/suppliers/environmental/TechNotes/TechNotes2001-02.pdf>

BSK & Associates (BSK). 2020. *Aviation Fuel Farm Removal Report – Livermore Municipal Airport, Livermore, CA*.

California Department of Toxic Substances Control (DTSC). 2014. DTSC file review notes for Livermore Navy Auxiliary Field #J09CA7295. September 25.

California Department of Toxic Substances Control (DTSC). 2015. *Concurrence with Finding of No Department of Defense Actions Indicated (NDAI) for Formerly Used Defense Sites in California*. January 22.

California Regional Water Quality Control Board (RWQCB). 2002. Order No. R2-2002-0041, *Updated Waste Discharge Requirements and Rescission [sic] of Order No. 97-050 for: Pleasanton Garbage Service Inc., Old Pleasanton Landfill, Pleasanton, Alameda County*. March 20.

California State Water Resources Control Board (SWRCB). 2020. GeoTracker. Accessed September 1, 2020. <https://geotracker.waterboards.ca.gov/>

City of Livermore. 2020. History of Livermore Municipal Airport. Accessed August 14, 2020. <http://www.cityoflivermore.net/civicax/filebank/documents/5727/>

Coffman Associates, Inc. 2014. Airport Layout Plan Update and Narrative Report for Livermore Municipal Airport, Livermore, California. September.

Department of Ecology State of Washington. 2018. *Quality Assurance Project Plan Per- and Polyfluoroalkyl Substances (PFAS) in Washington State Products Product Testing Program*. Publication 18-04-012. June.

EBA Engineering. 2020. *April 2020 Annual Discharge Monitoring Report for Old Pleasanton Landfill, Alameda County, California*. April 30.

Hu, X.C., D.Q. Andrews, A.B. Lindstrom, T.A. Bruton, L.A. Schaider, P. Grandjean, R. Lohmann, C.C. Carignan, A. Blum, S.A. Balan, C.P. Higgins, and E.M. Sunderland. 2016. "Detection of Poly- and Perfluoroalkyl Substances (PFASs) in U.S. Drinking Water Linked to Industrial Sites, Military Fire Training Areas, and Wastewater Treatment Plants." *Environmental Science & Technology Letters*. Vol. 3(10):344-350. October 11.

Interstate Technology and Regulatory Council (ITRC). 2017. *History and Use of Per- and Polyfluoroalkyl Substances (PFAS)*. November.

Interstate Technology and Regulatory Council (ITRC). 2018a. *Aqueous Film-Forming Foam (AFFF)*. October.

Interstate Technology and Regulatory Council (ITRC). 2018b. *Environmental Fate and Transport for Per- and Polyfluoroalkyl Substances*. March.

Keese, Dale. 2020. *Best Natural Stone Sealer (2020): Reviews and Comparison*. January 1. Accessed January 9, 2020. <https://sealwithease.com/best-natural-stone-sealer/>

Kissa, E. 1994. *Fluorinated surfactants: synthesis, properties, applications*. New York, Marcel Dekker Inc.

Lang, J.R., B.K. Allred, J.A. Field, J.W. Levis, and M.A. Barlaz. 2017. "National Estimate of Per- and Polyfluoroalkyl Substance (PFAS) Release to U.S. Municipal Landfill Leachate." *Environmental Science and Technology*. Vol. 51: 2197-2205.

Las Positas College. 2020. *Las Positas College History, and Fire Service Technology Program*. Accessed September 30, 2020. <http://www.laspositascollege.edu/about/index.php> and <http://www.laspositascollege.edu/fst/index.php>.

LSA Associates, Inc. 2009. *Public Review Draft, Livermore Municipal Airport General Plan Amendment and Rezoning Project Environmental Impact Report, State Clearinghouse No. 2008102103*. September.

Luhdorff & Scalmanini Consulting Engineers (Luhdorff & Scalmanini). 2017. *Dublin San Ramon Services District FSL/DLD Site Groundwater Monitoring Report. Pleasanton, California*.

Paulson, K., C. Matzdorf, and S. Swarts. 2004. *Final Report for the Use of Wetting Agents/Fume Suppressants for Minimizing the Atmospheric Emissions from Hard Chromium Electroplating Baths*. March. NAVFAC Technical Report TR-2243-ENV.

Riordan, B.J., R.T. Karamchandani, L.J. Zitko, and G.C. Cushnie Jr. 1998. *Capsule Report: Hard Chrome Fume Suppressants and Control Technologies*. EPA/625/R-98/002 (NTIS PB2001-105628). December.

San Francisco Bay Regional Water Quality Control Board (SFRWQCB). 2017. National Pollutant Discharge Elimination System (NPDES) for the Dublin San Ramon Services District, Livermore Amador Valley Water Management Agency and East Bay Dischargers Authority. 2017. San Francisco Bay Regional Water Quality Control Board, Oakland, California.

Subsurface Consultants, Inc. (SCI). 2002. *Investigation and Remediation Former Incinerator/Burn Dump Parcel and Digital Drive Santa Rita Property. Dublin, California.* SCI 1072.017.

U.S. Army Environmental Command. 2016. *FY2016 – Parks Reserve Forces Training Area, Army Defense Environmental Restoration Program, Installation Action Plan.* September 27.

U.S. Department of the Army. 2016. *Proposed Plan for Installation Restoration Site CCPRFTA-06 U.S. Army Garrison Camp Parks, Dublin, California.* February 10.

U.S. Environmental Protection Agency (EPA). 2019. *EPA Per- and Polyfluoroalkyl Substances Action Plan.* February.

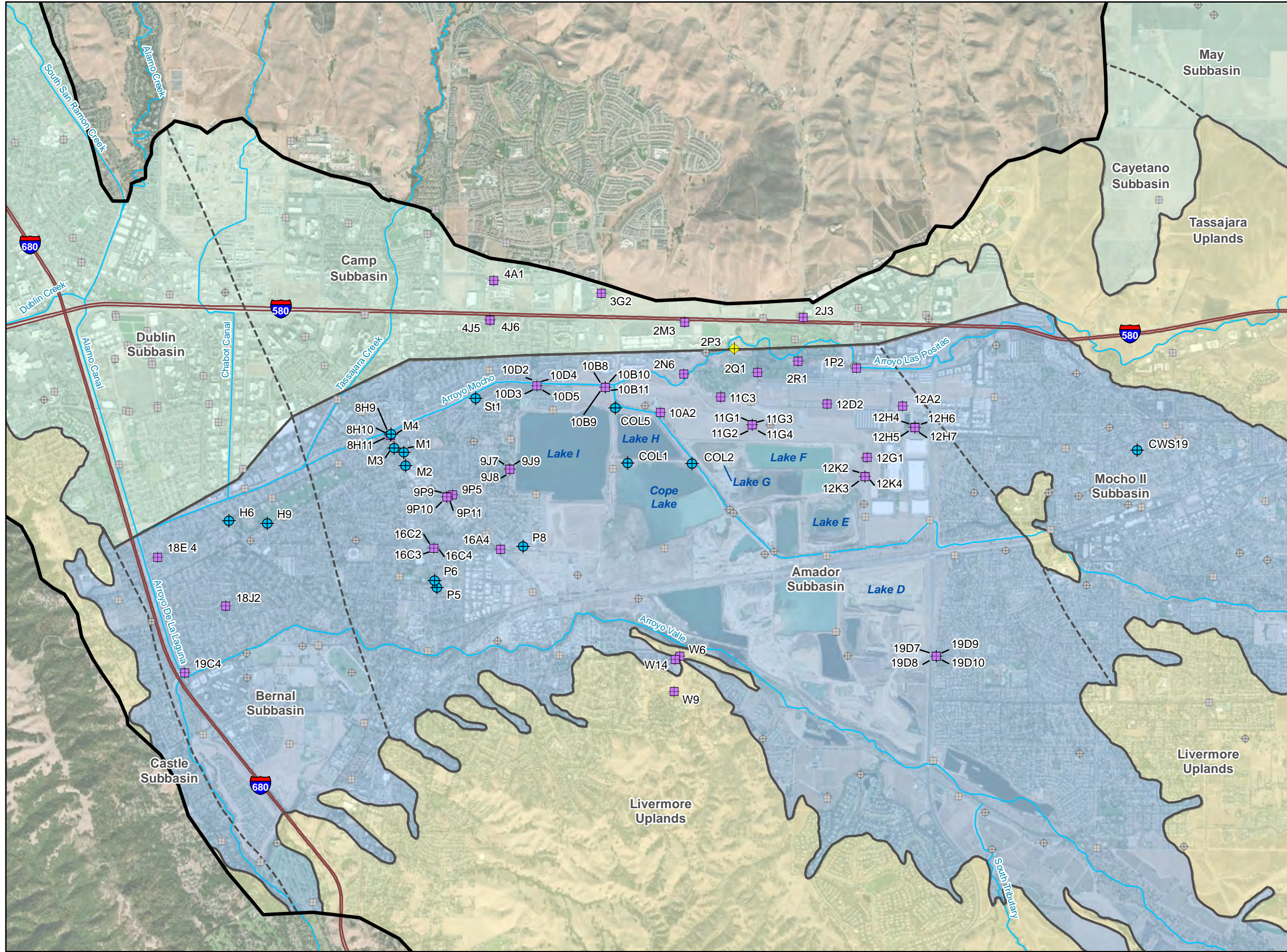
U.S. Environmental Protection Agency (EPA). 2020. *EPA PFAS Action Plan: Program Update.* February.

Water Environment Federation. 1996. *Developing Source Control Programs for Commercial and Industrial Wastewater.*

Wei, Z., T. Xu, and D. Zhao. 2019. "Treatment of per- and polyfluoroalkyl substances in landfill leachate: status, chemistry and prospects." *Environmental Science: Water Research and Technology.* Vol. 5: 1814-1835.

Zone 7 Water Agency (Zone 7). 2020. *Annual Report for the Sustainable Groundwater Management Program, 2019 Water Year (October 2018 – September 20-19) Livermore Groundwater Basin.* March.

Figures



Legend

- Monitoring Well
- ⊕ Municipal Well
- ◆ Domestic Well
- Monitoring Well
- ⊕ Municipal Well
- ▭ Livermore Valley Groundwater Basin
- ▭ Main Basin Management Area and Subareas
- ▭ Fringe Management Area and Subareas
- ▭ Upland Management Area
- - - Subbasin Boundary
- Interstate
- Stream

Basemap Source: Esri World Imagery

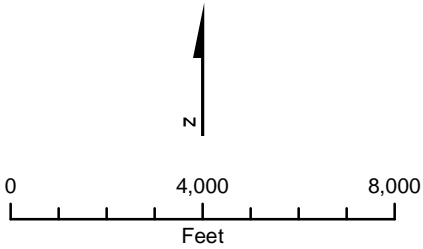
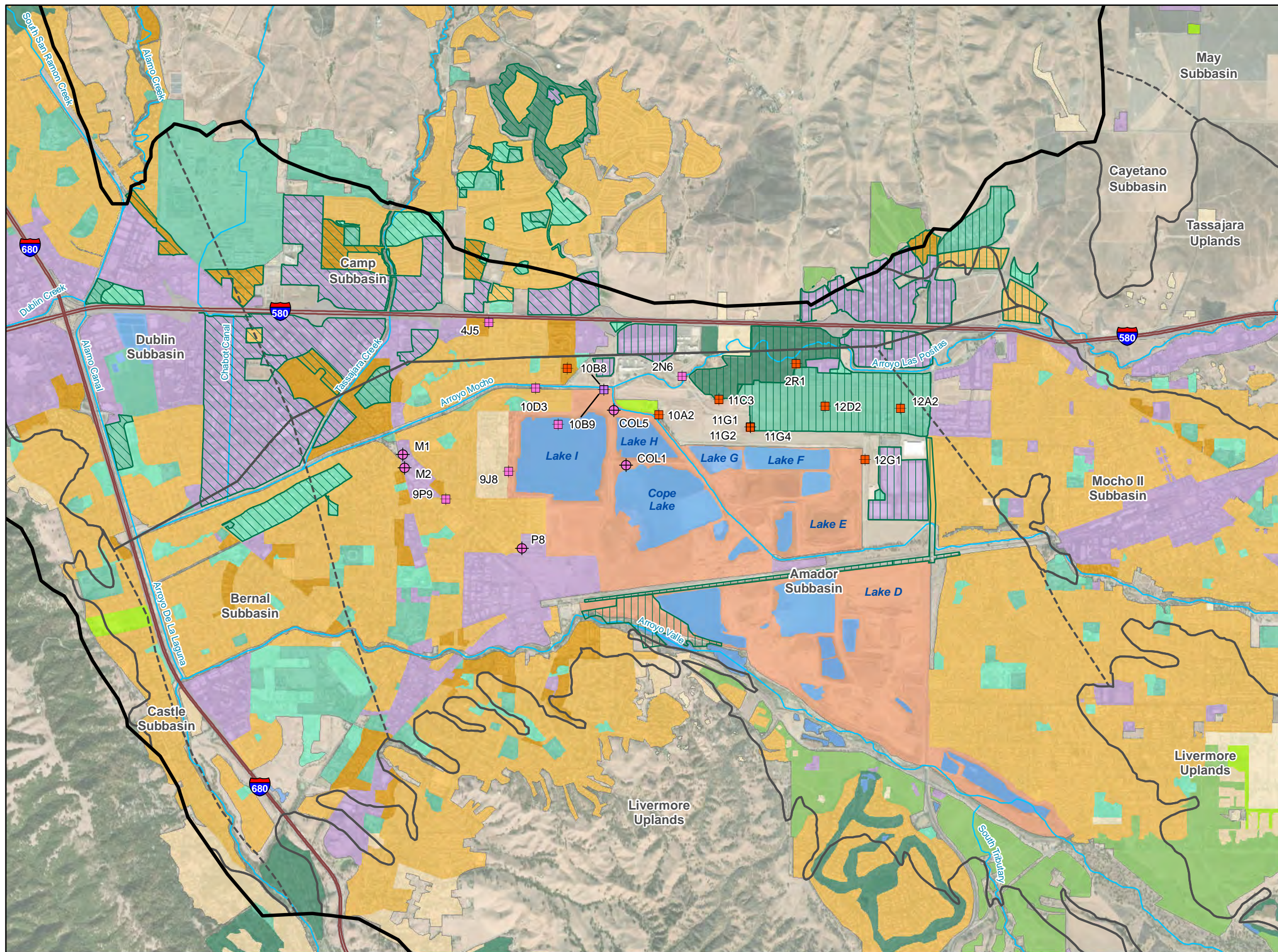


Figure 1. Site Location
 PFAS Potential Source Investigation
 Zone 7 Water Agency



Legend

- Monitoring Well*
- Municipal Well*
- Irrigated with DSRSD Effluent
- Irrigated with LWRP Effluent
- Livermore Valley Groundwater Basin
- Management Area Boundary
- Subbasin Boundary
- Interstate
- Stream

Land Use

- Residential (rural)
- Residential (low density)
- Residential (medium density)
- Residential (high density)
- Commercial and Business
- Agriculture (non-vineyard)
- Agriculture (vineyard)
- Golf Course
- Mining Area (pit)
- Public
- Public (Irrigated Park)
- Roads
- Water
- Open Space

Basemap Source: Esri World Imagery

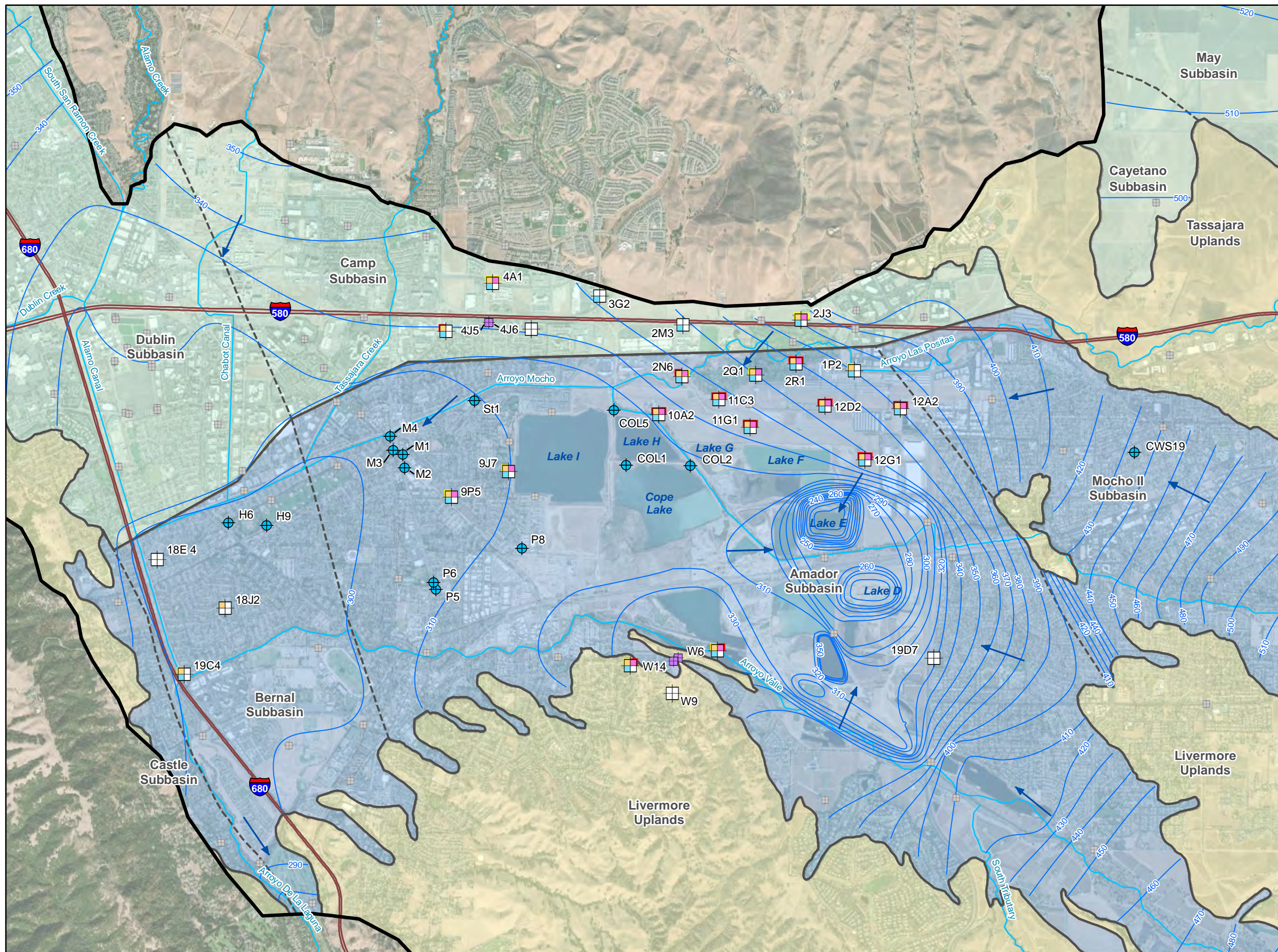
***Well Symbolology:**

- PFOS Exceeded Response Level
- PFOA and PFOS Exceeded Response Level

0 4,000 8,000
Feet

Figure 2. Land Use and Areas of Recycled Water Application
 PFAS Potential Source Investigation
 Zone 7 Water Agency

\\gal\proj\Zone_7\W8Y06500\MapFiles\Land_Use_200630.mxd



- Legend**
- Monitoring Well*
 - Municipal Well
 - Other Upper Aquifer Monitoring Well
 - Groundwater Elevation Contour, Fall 2019 (feet above mean sea level)
 - Groundwater Flow Direction (Upper Aquifer)
 - Main Basin
 - Main Basin Management Area and Subareas
 - Fringe Management Area and Subareas
 - Upland Management Area
 - Subbasin Boundary
 - Interstate
 - Stream

Basemap Source: Esri World Imagery

***Well Symbolology:**

- Yellow Outline = Notification Level Exceeded
- Red Outline = Response Level Exceeded
- Orange Fill = PFOS Detected
- Pink Fill = PFOA Detected
- Blue Fill = Other of 7 PFAS Detected

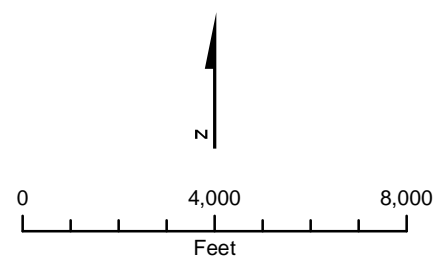
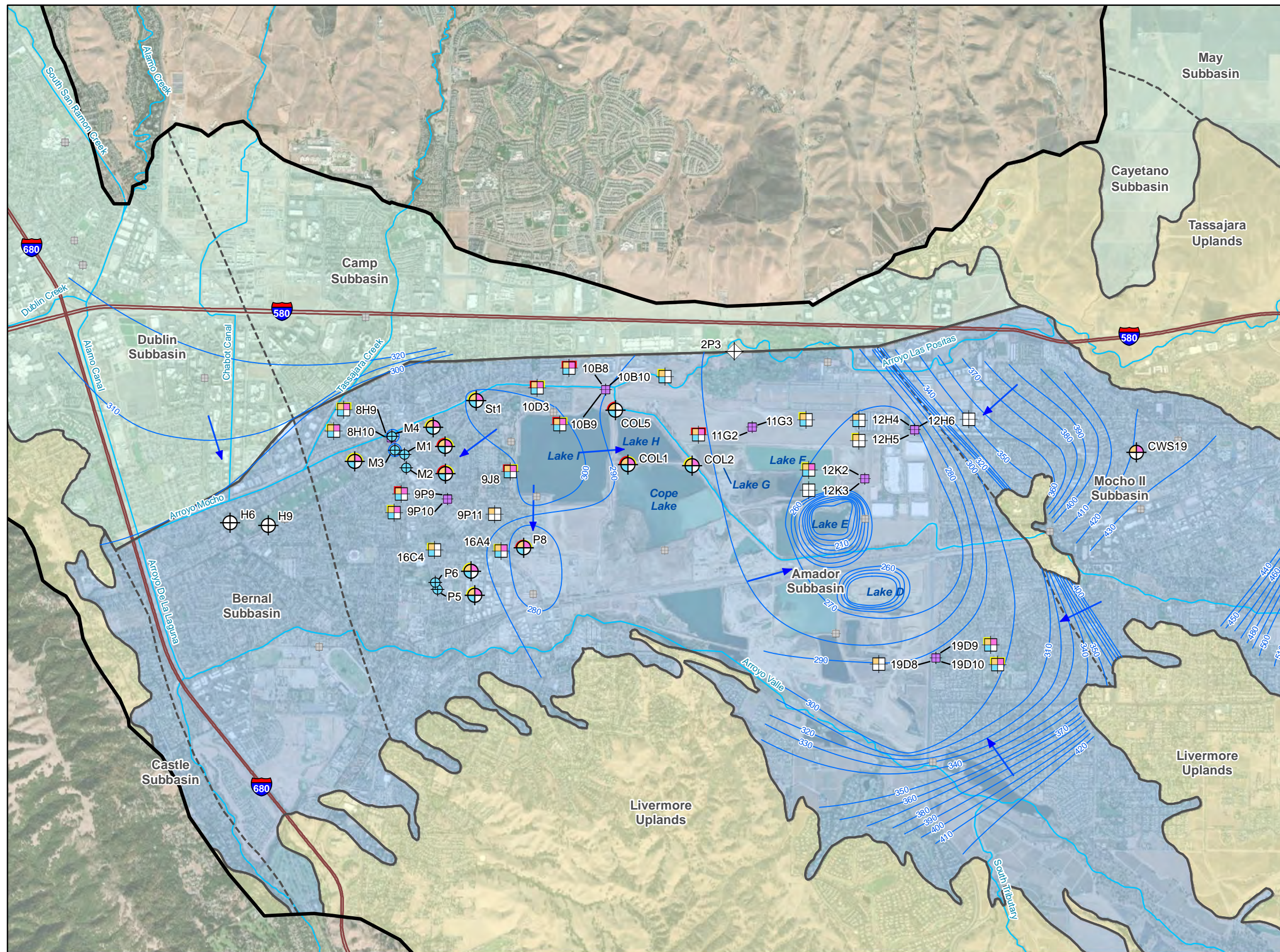


Figure 3. PFAS Detections in Upper Aquifer
 PFAS Potential Source Investigation
 Zone 7 Water Agency



- Legend**
- ◆ Domestic Well*
 - Monitoring Well*
 - ⊕ Municipal Well*
 - Other Lower Aquifer Monitoring Well
 - Groundwater Elevation Contour, Fall 2019 (feet above mean sea level)
 - Groundwater Flow Direction (Lower Aquifer)
 - ▭ Livermore Valley Groundwater Basin
 - ▭ Main Basin Management Area and Subareas
 - ▭ Fringe Management Area and Subareas
 - ▭ Upland Management Area
 - - - Subbasin Boundary
 - Interstate
 - Stream

Basemap Source: Esri World Imagery

*Well Symbology:

- Yellow Outline = Notification Level Exceeded
- Red Outline = Response Level Exceeded
- Orange Fill = PFOS Detected
- Pink Fill = PFOA Detected
- Blue Fill = Other of 7 PFAS Detected

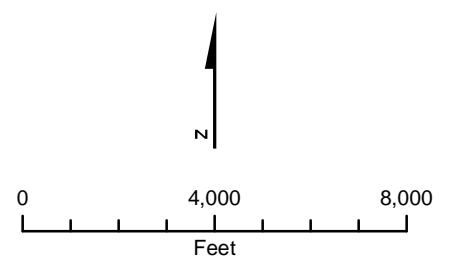
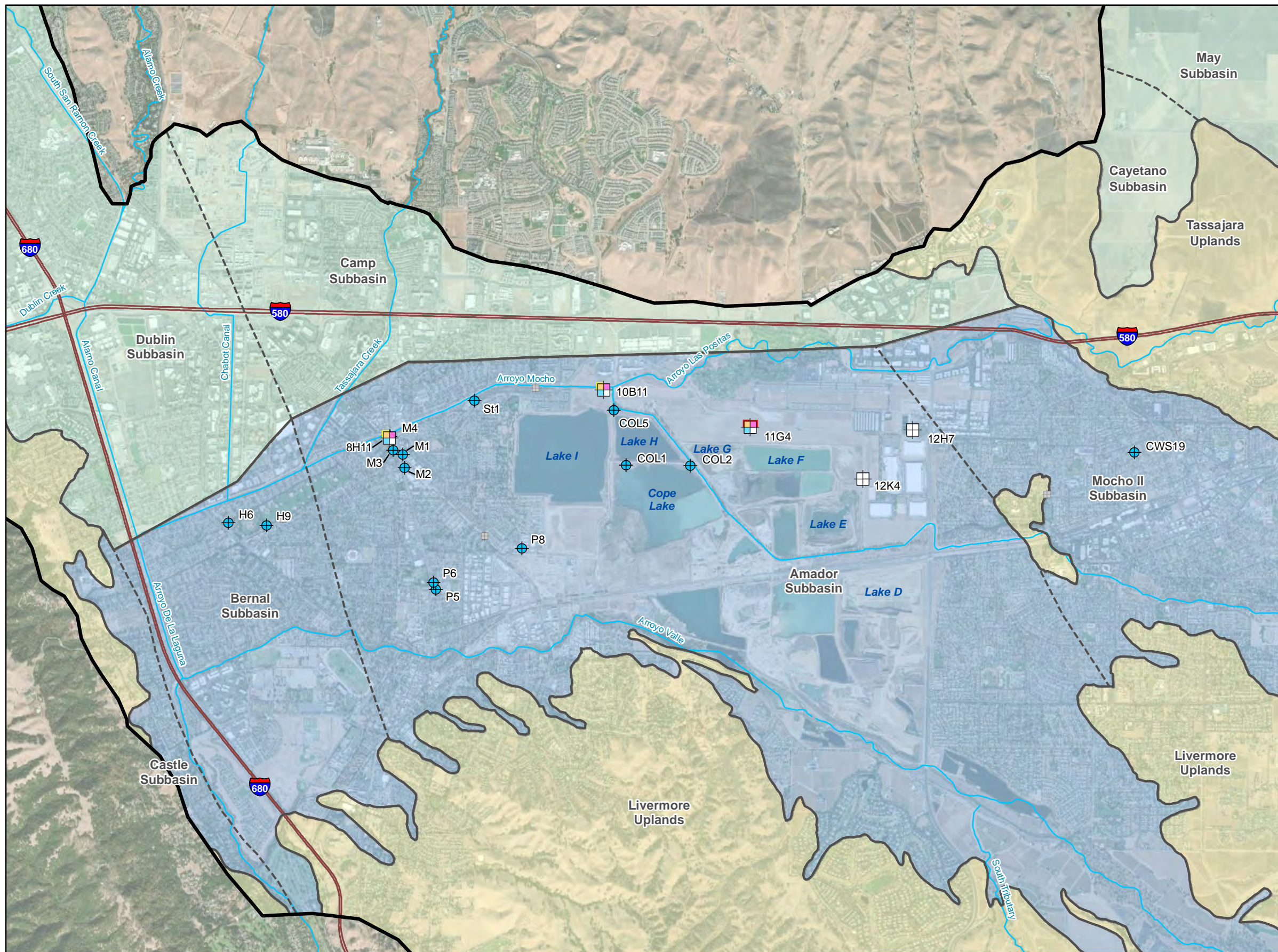


Figure 4. PFAS Detections in Lower Aquifer
 PFAS Potential Source Investigation
 Zone 7 Water Agency



- Legend**
- Monitoring Well*
 - ⊕ Municipal Well
 - Other Deep Aquifer Monitoring Well
 - ▭ Livermore Valley Groundwater Basin
 - ▭ Main Basin Management Area and Subareas
 - ▭ Fringe Management Area and Subareas
 - ▭ Upland Management Area
 - - - Subbasin Boundary
 - Interstate
 - Stream

Basemap Source: Esri World Imagery

***Well Symbology:**

- Yellow Outline = Notification Level Exceeded
- Red Outline = Response Level Exceeded
- Orange Fill = PFOS Detected
- Pink Fill = PFOA Detected
- Blue Fill = Other of 7 PFAS Detected

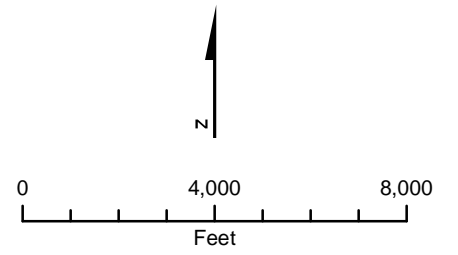
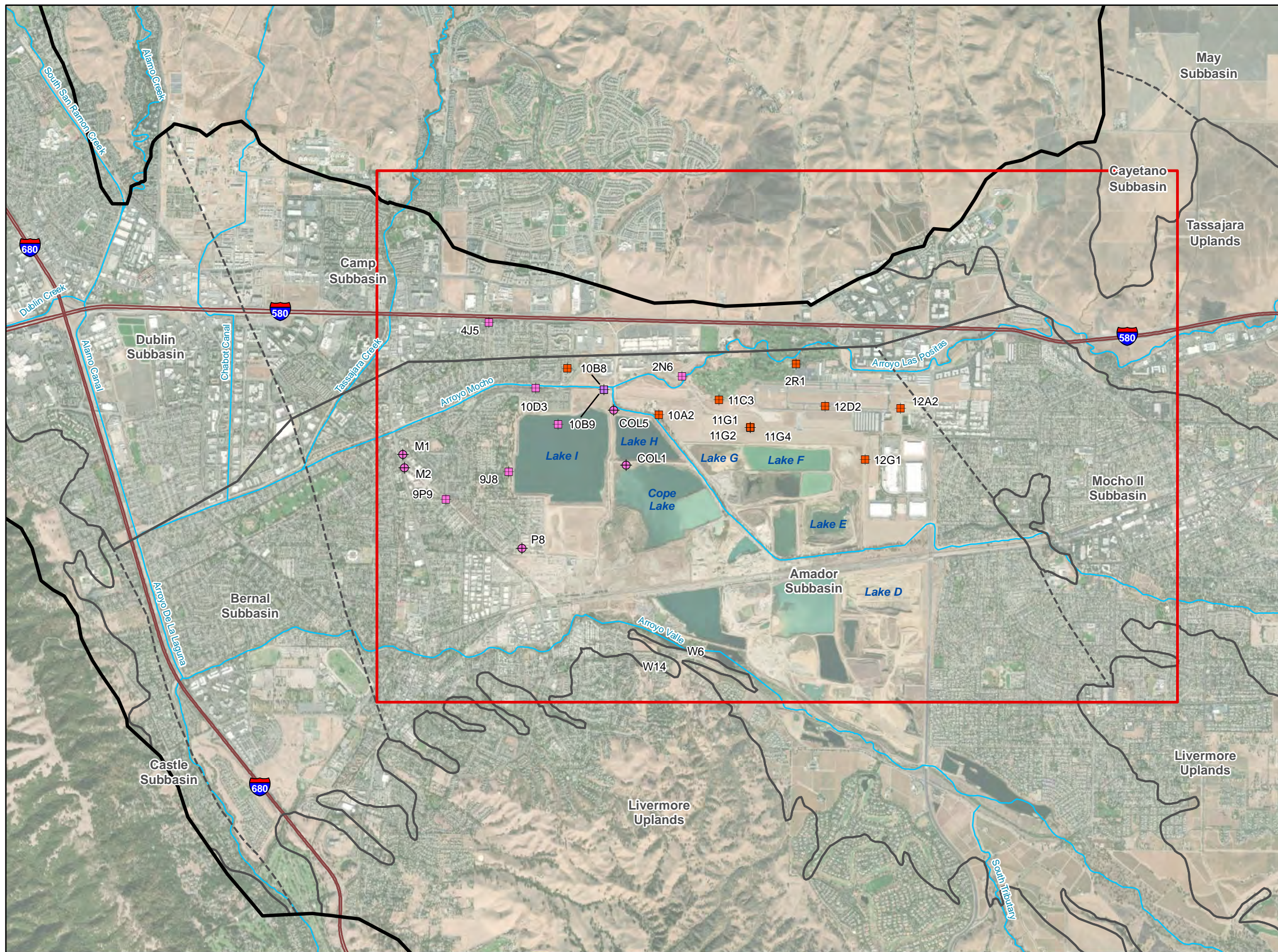


Figure 5. PFAS Detections in Deep Aquifer
 PFAS Potential Source Investigation
 Zone 7 Water Agency



Legend

- Search Area
- Monitoring Well*
- Municipal Well*
- Livermore Valley Groundwater Basin
- Management Area Boundary
- Subbasin Boundary
- Interstate
- Stream

Basemap Source: Esri World Imagery

*Well Symbology:

- PFOS Exceeded Response Level
- PFOA and PFOS Exceeded Response Level

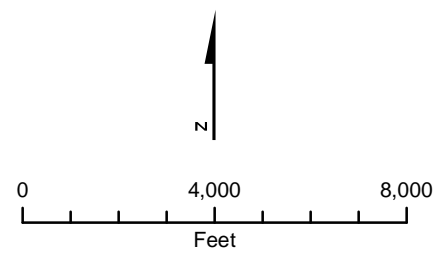
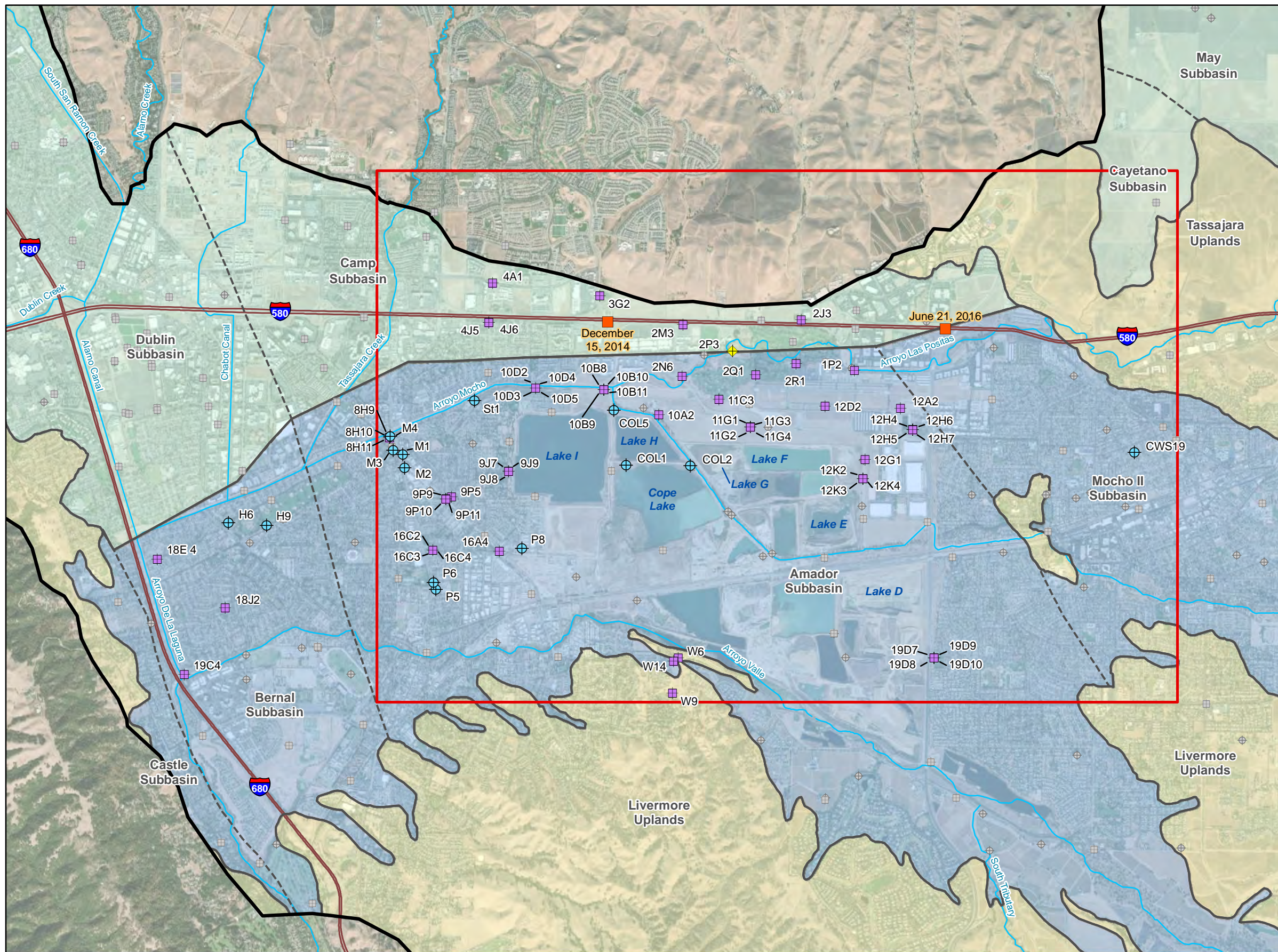


Figure 6. Search Area for Potetnial PFAS Sources
 PFAS Potential Source Investigation
 Zone 7 Water Agency



Legend

- Search Area
- Emergency Response Site
- Monitoring Well
- Municipal Well

Wells with PFAS Data

- ◆ Domestic Well
- Monitoring Well
- ⊕ Municipal Well

- Livermore Valley Groundwater Basin
- Main Basin Management Area and Subareas
- Fringe Management Area and Subareas
- Upland Management Area
- Subbasin Boundary
- Interstate
- Stream

Basemap Source: Esri World Imagery

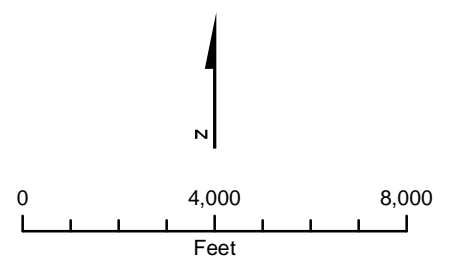
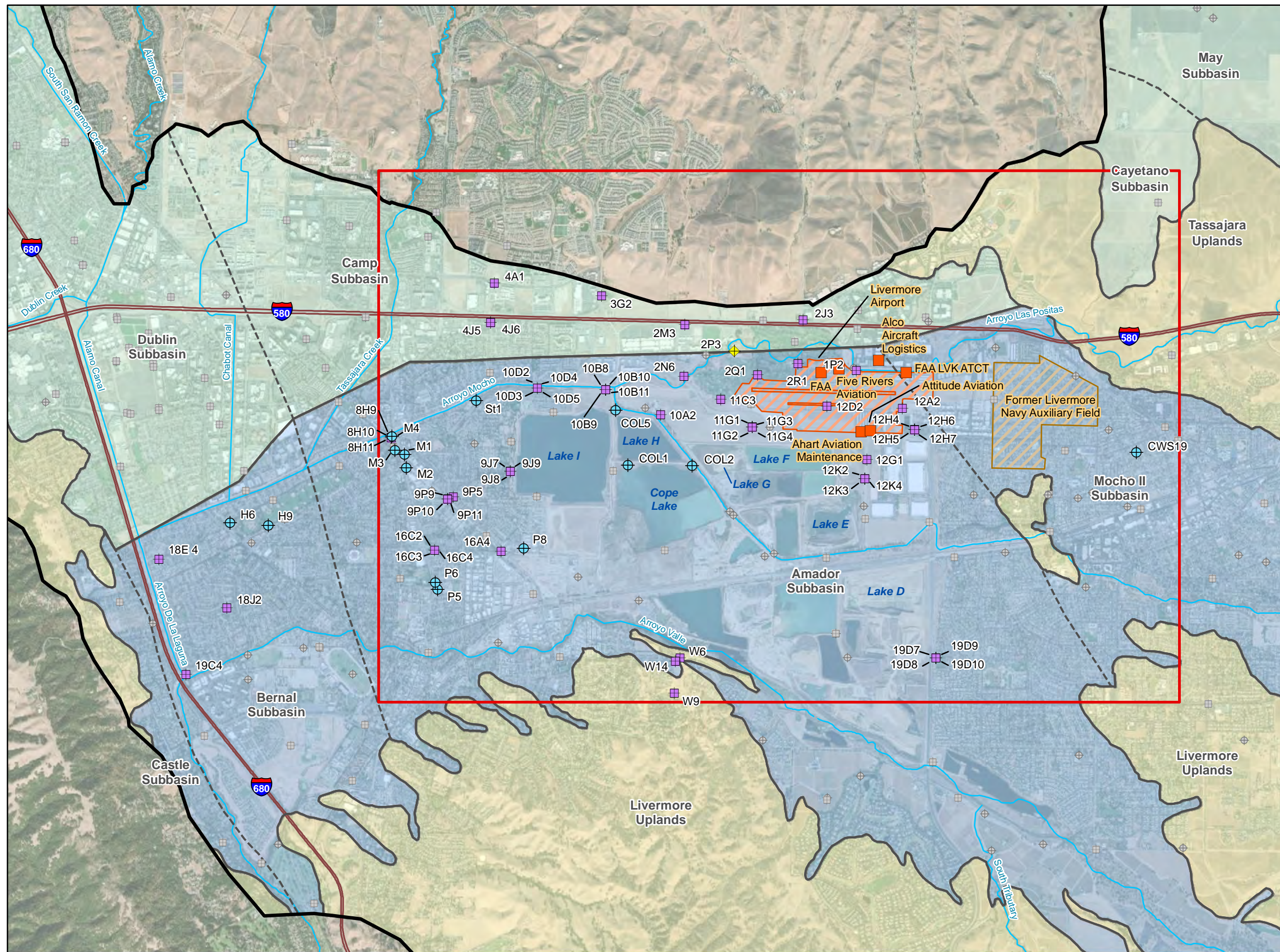


Figure 7. Emergency Response Sites
 PFAS Potential Source Investigation
 Zone 7 Water Agency



Legend

- Search Area
- Airports and Related Facilities
- Livermore Municipal Airport
- Former Livermore Navy Auxiliary Field
- Monitoring Well
- Municipal Well

Wells with PFAS Data

- + Domestic Well
- + Monitoring Well
- + Municipal Well

- Livermore Valley Groundwater Basin
- Main Basin Management Area and Subareas
- Fringe Management Area and Subareas
- Upland Management Area
- Subbasin Boundary
- Interstate
- Stream

Basemap Source: Esri World Imagery

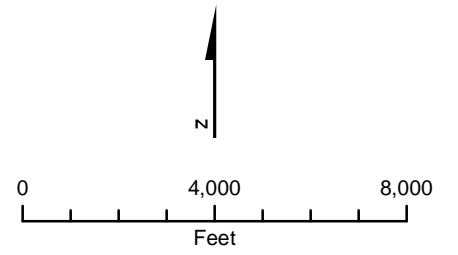
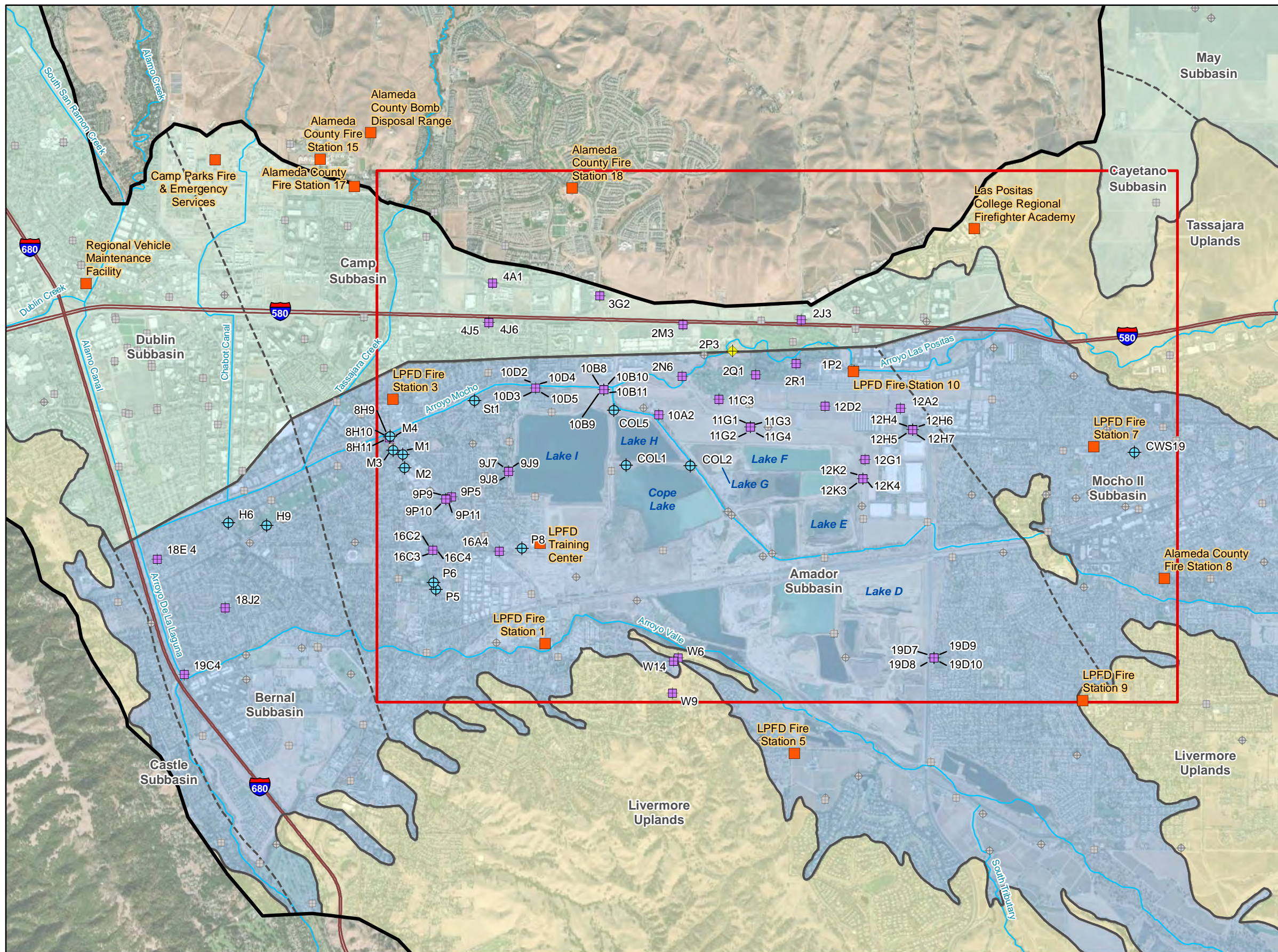


Figure 8. Livermore Airport Facilities and Possible Use of AFFF
 PFAS Potential Source Investigation
 Zone 7 Water Agency



Legend

- Search Area
- Fire Station
- Monitoring Well
- Municipal Well

Wells with PFAS Data

- Domestic Well
- Monitoring Well
- Municipal Well

Basin Management Areas

- Livermore Valley Groundwater Basin
- Main Basin Management Area and Subareas
- Fringe Management Area and Subareas
- Upland Management Area

Other Features

- Subbasin Boundary
- Interstate
- Stream

Basemap Source: Esri World Imagery

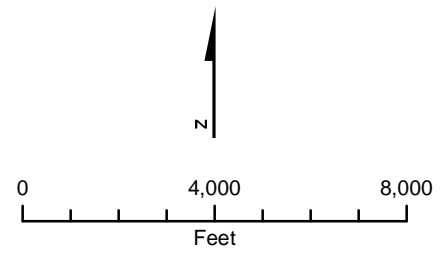
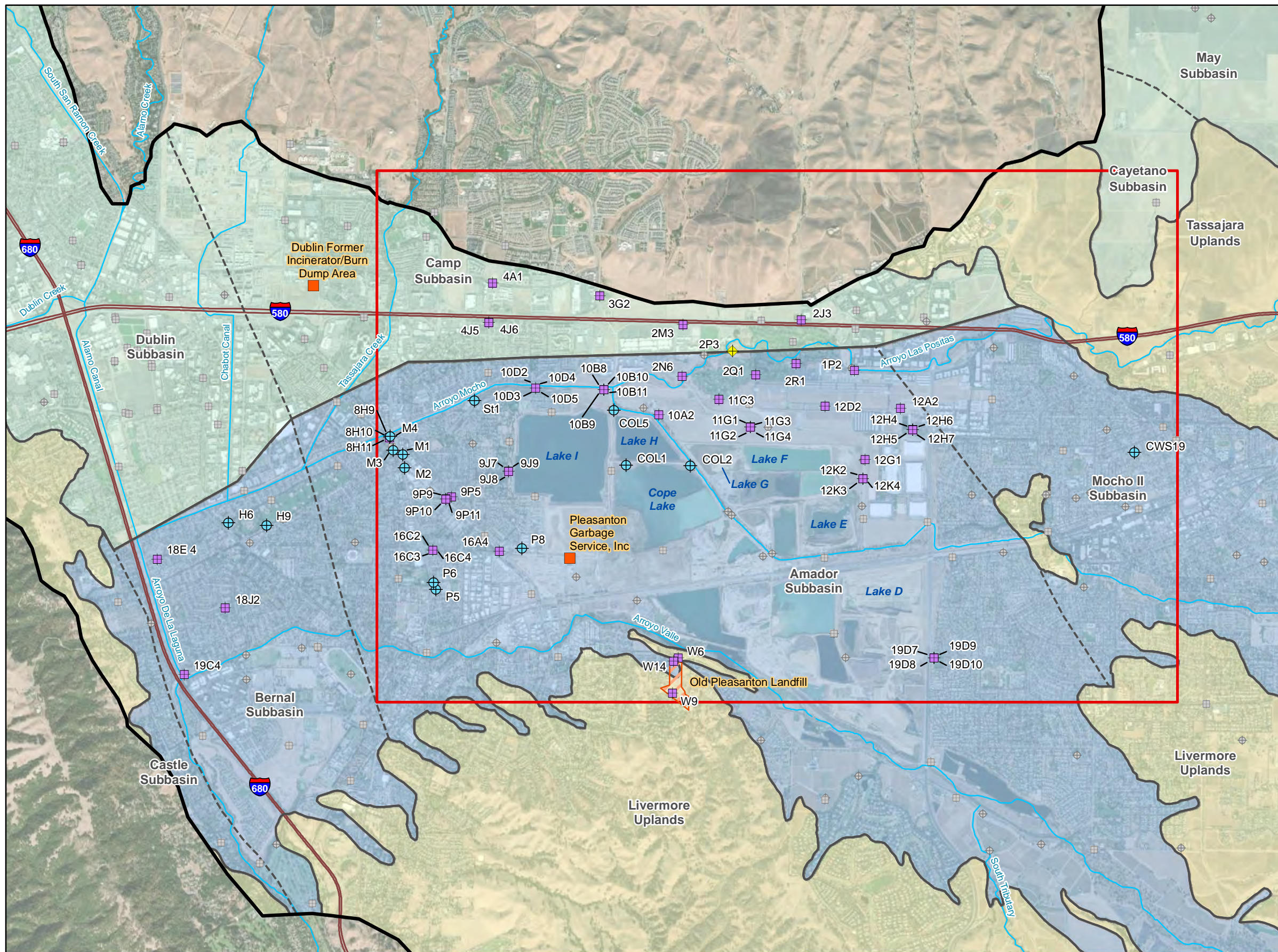


Figure 9. Fire Stations and Firefighting Training Areas with Possible Use of AFFF
 PFAS Potential Source Investigation
 Zone 7 Water Agency



- Legend**
- Search Area
 - Landfills
 - Old Pleasanton Landfill
 - Monitoring Well
 - Municipal Well
- Wells with PFAS Data**
- ◆ Domestic Well
 - Monitoring Well
 - Municipal Well
- Livermore Valley Groundwater Basin
 - Main Basin Management Area and Subareas
 - Fringe Management Area and Subareas
 - Upland Management Area
 - Subbasin Boundary
 - Interstate
 - Stream

Basemap Source: Esri World Imagery

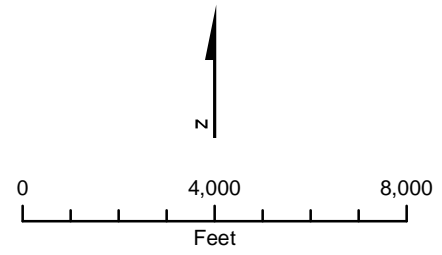
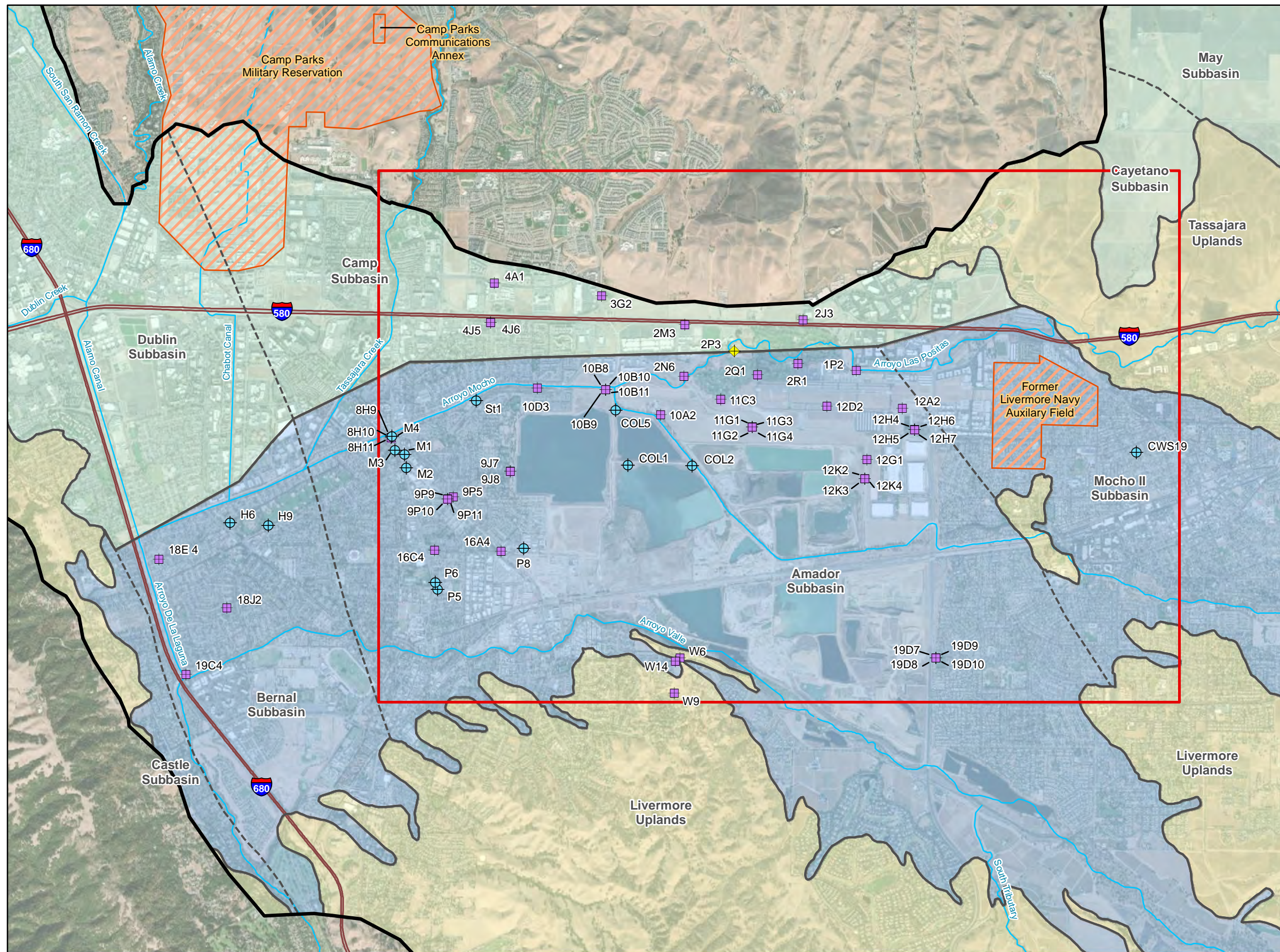


Figure 10. Landfills and Solid Waste Disposal Sites
 PFAS Potential Source Investigation
 Zone 7 Water Agency



Legend

- Search Area
- Military Facility
- ◆ Domestic Well
- Monitoring Well
- ⊕ Production Well
- Livermore Valley Groundwater Basin
- Main Basin Management Area and Subareas
- Fringe Management Area and Subareas
- Upland Management Area
- Subbasin Boundary
- Interstate
- Stream

Basemap Source: Esri World Imagery

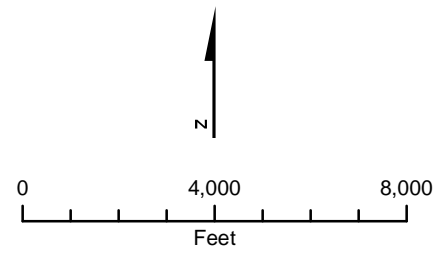
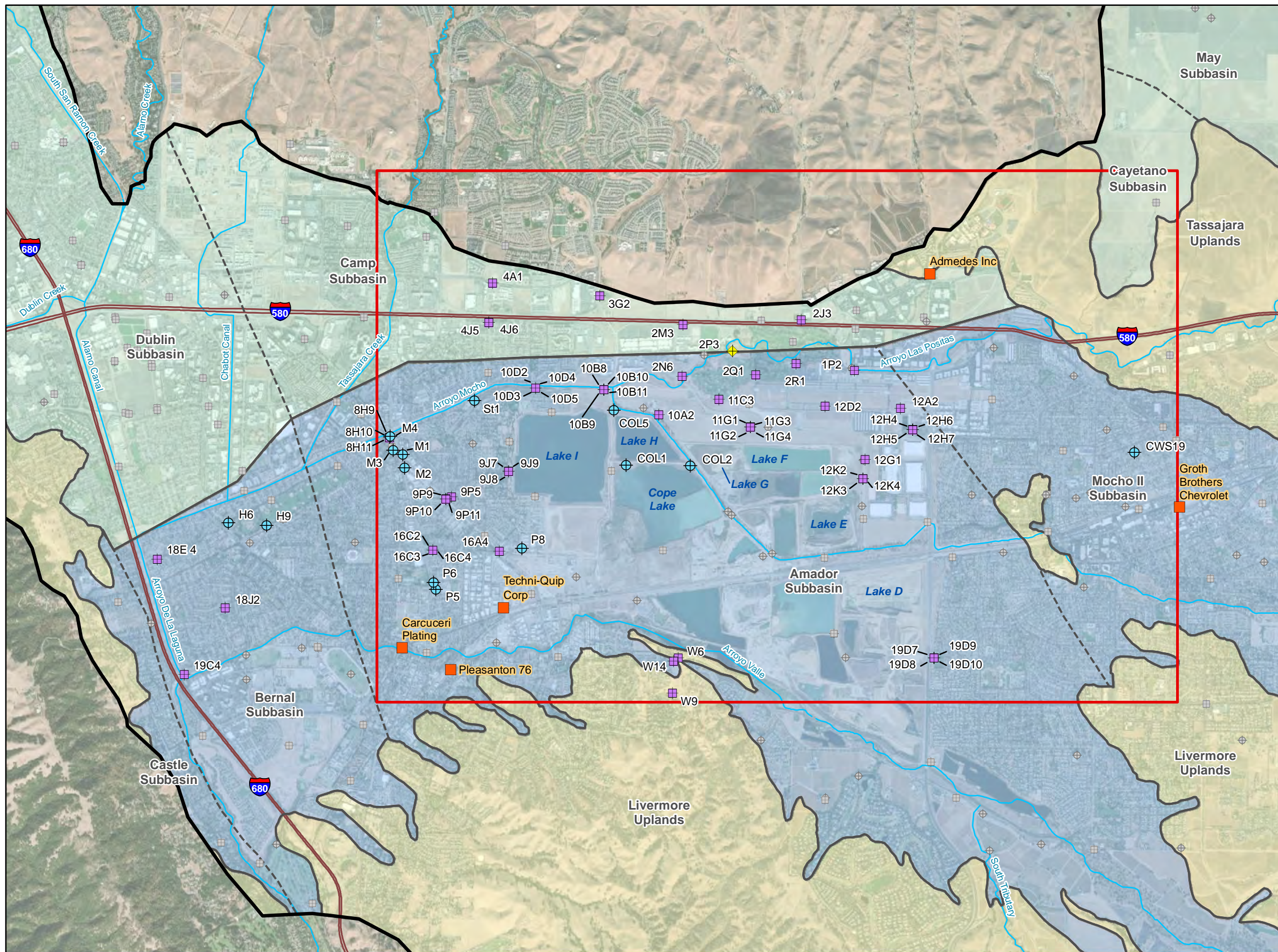


Figure 11. Military Facilities
 PFAS Potential Source Investigation
 Zone 7 Water Agency



Legend

- Search Area
- Plating Facility
- Monitoring Well
- Municipal Well

Wells with PFAS Data

- + Domestic Well
- + Monitoring Well
- + Municipal Well

- Livermore Valley Groundwater Basin
- Main Basin Management Area and Subareas
- Fringe Management Area and Subareas
- Upland Management Area
- Subbasin Boundary
- Interstate
- Stream

Basemap Source: Esri World Imagery

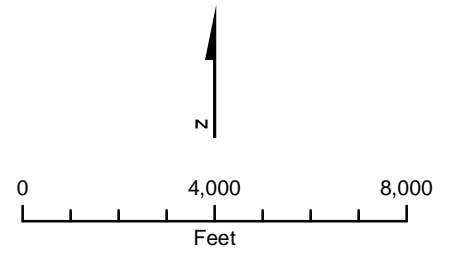
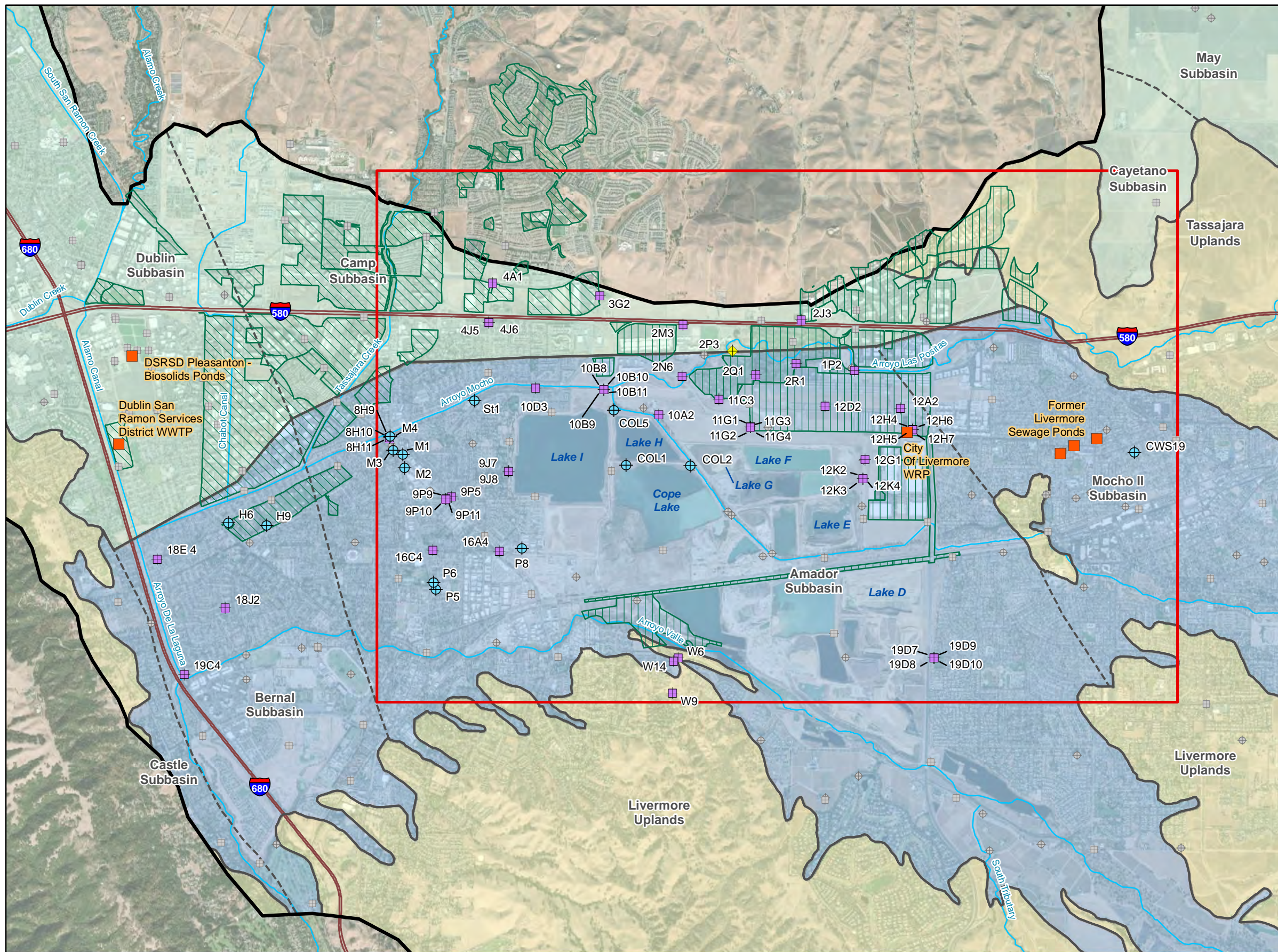
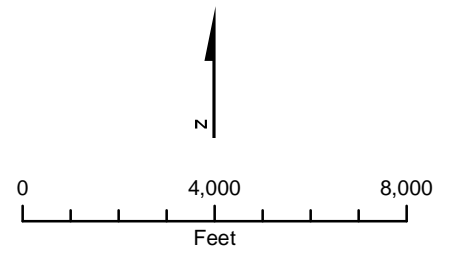


Figure 12. Plating Facilities
 PFAS Potential Source Investigation
 Zone 7 Water Agency

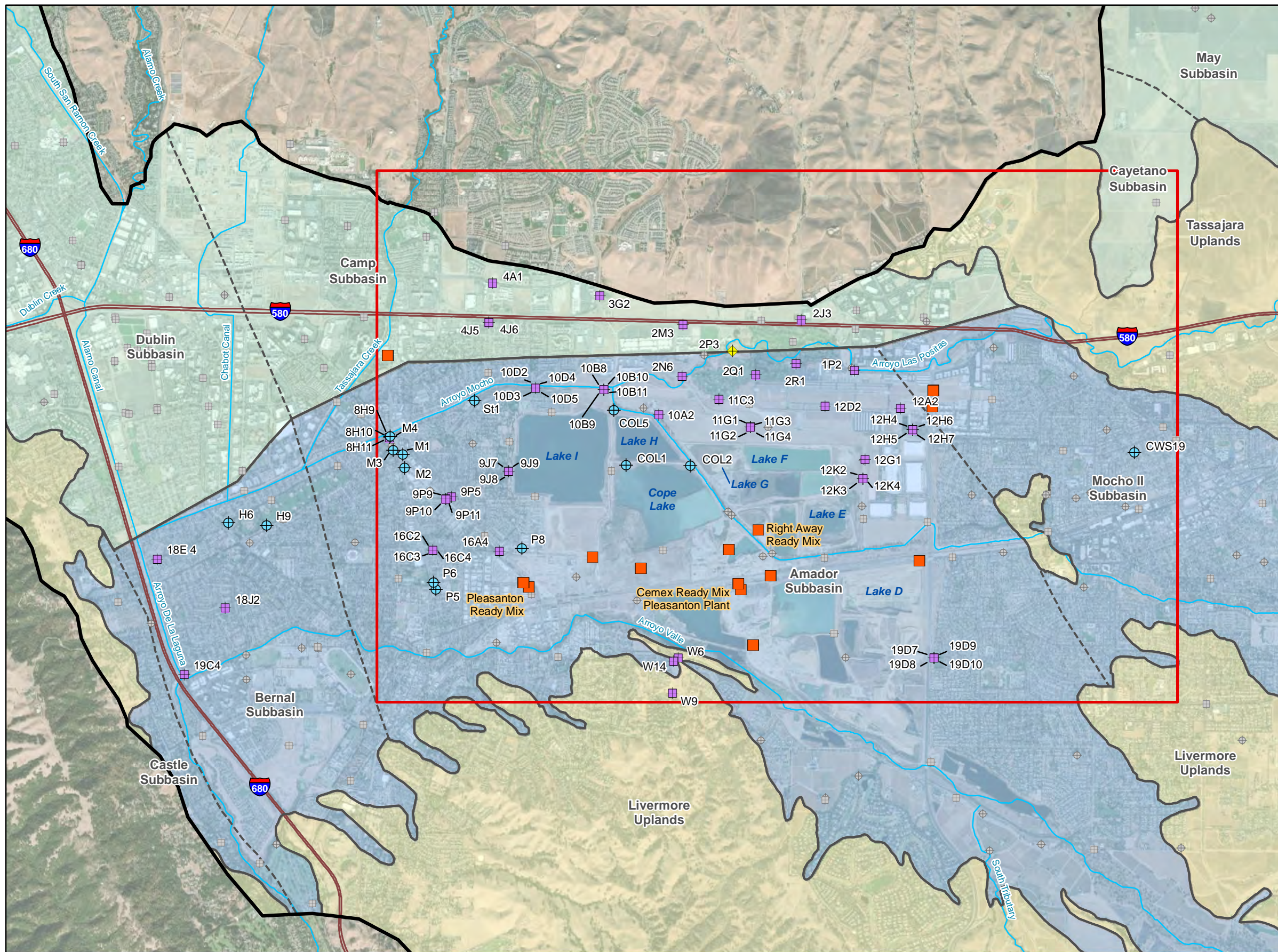


- Legend**
- Search Area
 - Wastewater Treatment Facility
 - Land Irrigated with DSRSD Effluent
 - Land Irrigated with LWRP Effluent
 - Monitoring Well
 - Municipal Well
- Wells with PFAS Data**
- Domestic Well
 - Monitoring Well
 - Production Well
- Livermore Valley Groundwater Basin
 - Main Basin Management Area and Subareas
 - Fringe Management Area and Subareas
 - Upland Management Area
 - Subbasin Boundary
 - Interstate
 - Stream

Basemap Source: Esri World Imagery



**Figure 13. Wastewater Treatment Facilities
PFAS Potential Source Investigation
Zone 7 Water Agency**



- Legend**
- Search Area
 - Cement Facility
 - Monitoring Well
 - Municipal Well
- Wells with PFAS Data**
- Domestic Well
 - Monitoring Well
 - Municipal Well
- Livermore Valley Groundwater Basin
 - Main Basin Management Area and Subareas
 - Fringe Management Area and Subareas
 - Upland Management Area
 - Subbasin Boundary
 - Interstate
 - Stream

Basemap Source: Esri World Imagery

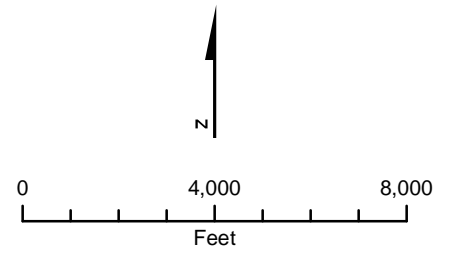
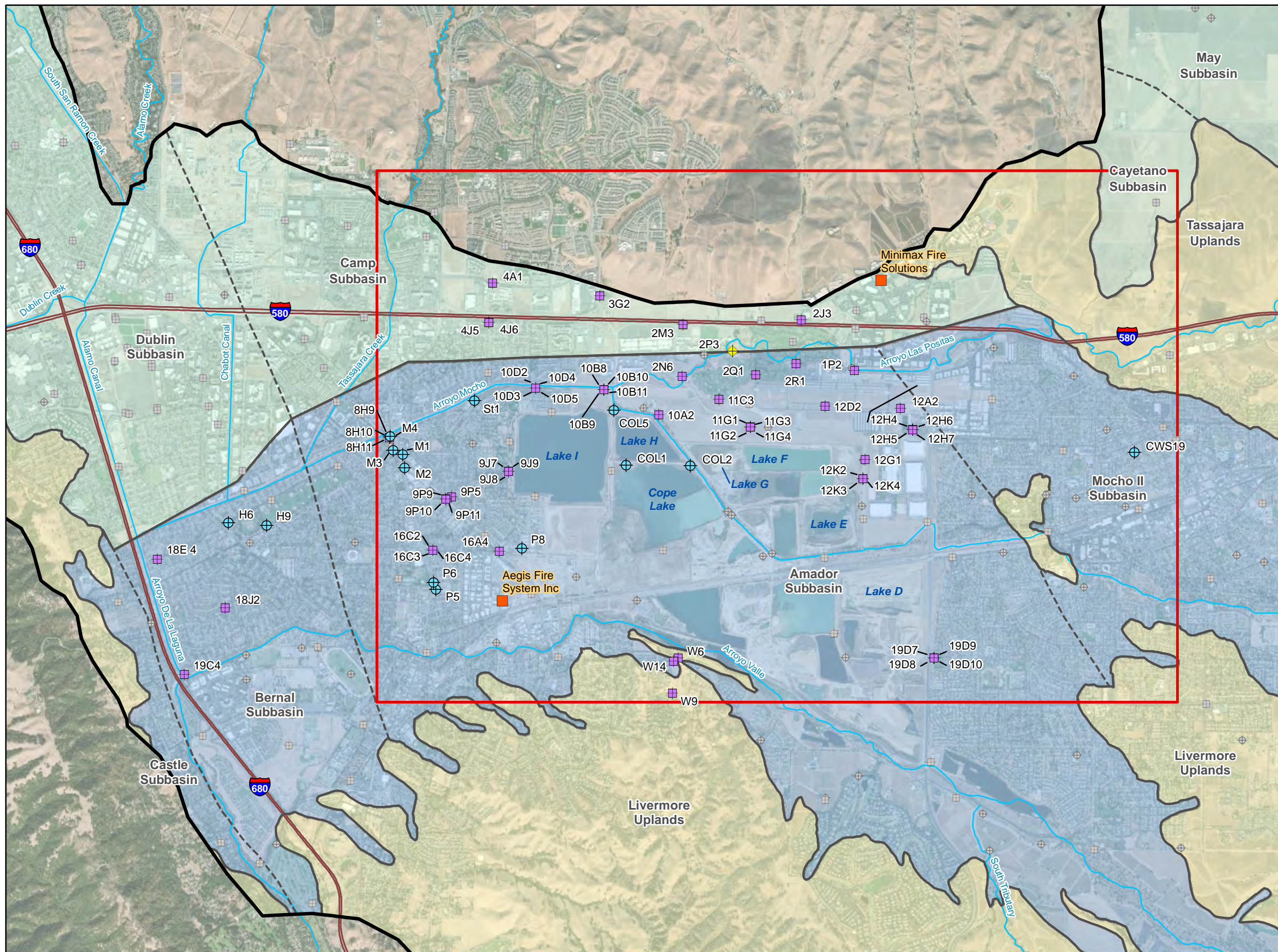
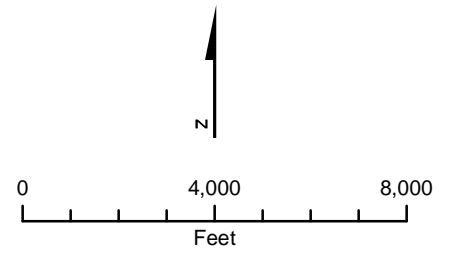


Figure 14. Cement Processing Sites
 PFAS Potential Source Investigation
 Zone 7 Water Agency

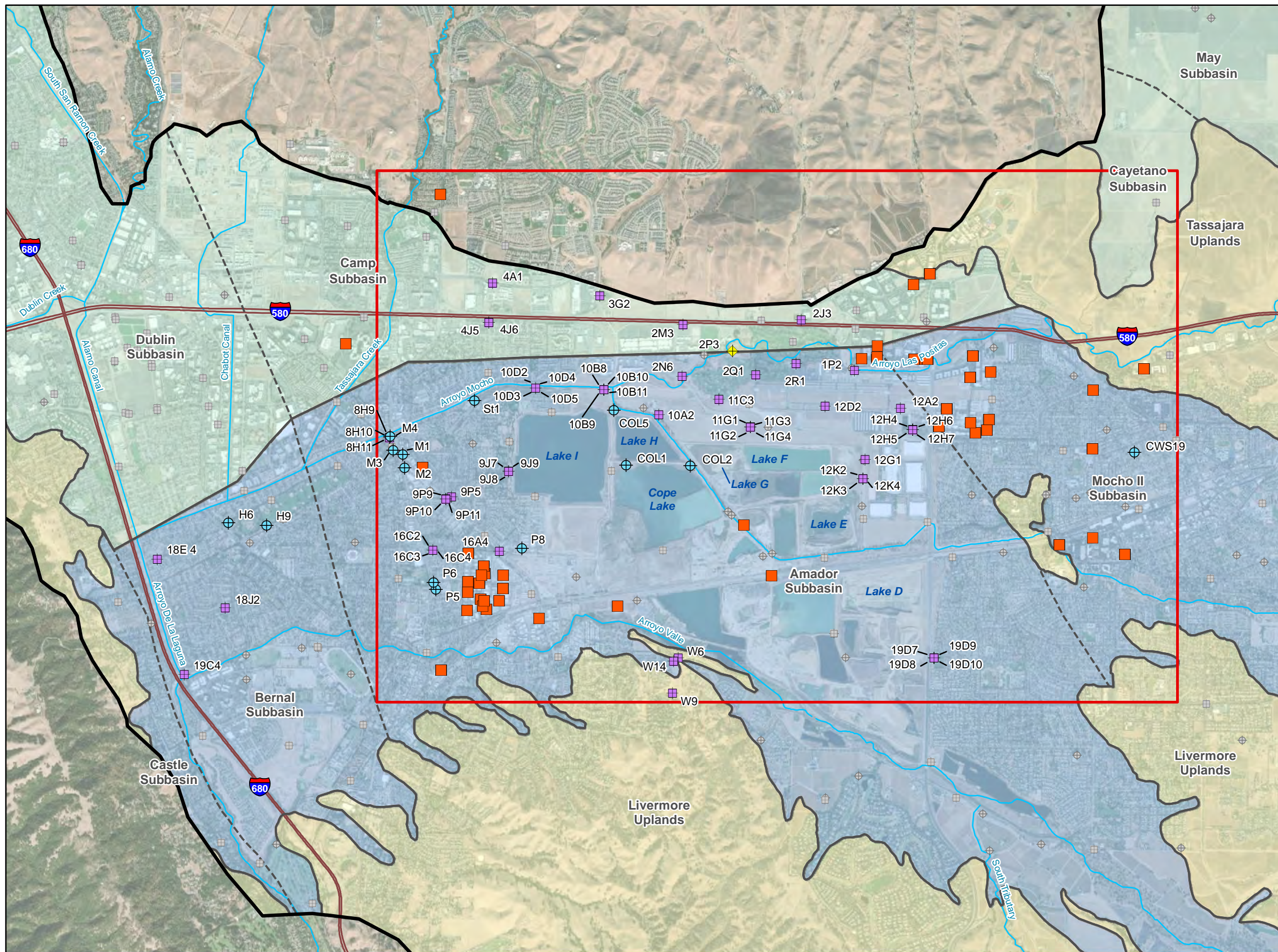


- Legend**
- Search Area
 - Fire Protection Facility
 - Monitoring Well
 - Municipal Well
 - Wells with PFAS Data**
 - Domestic Well
 - Monitoring Well
 - Municipal Well
 - Livermore Valley Groundwater Basin
 - Main Basin Management Area and Subareas
 - Fringe Management Area and Subareas
 - Upland Management Area
 - Subbasin Boundary
 - Interstate
 - Stream

Basemap Source: Esri World Imagery

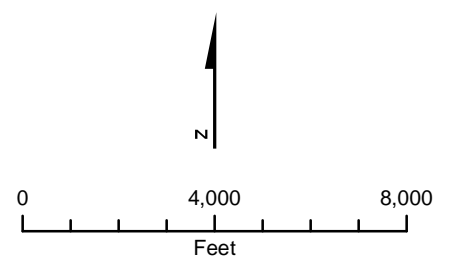


**Figure 15. Fire Protection Facilities
PFAS Potential Source Investigation
Zone 7 Water Agency**

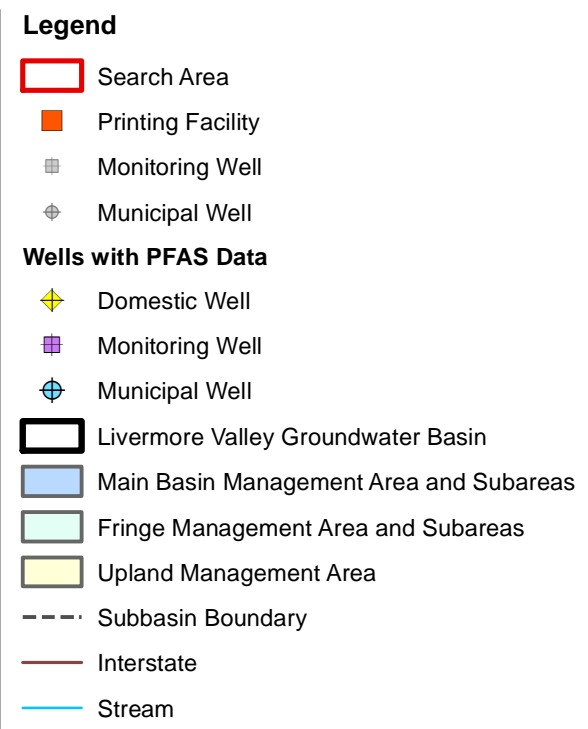
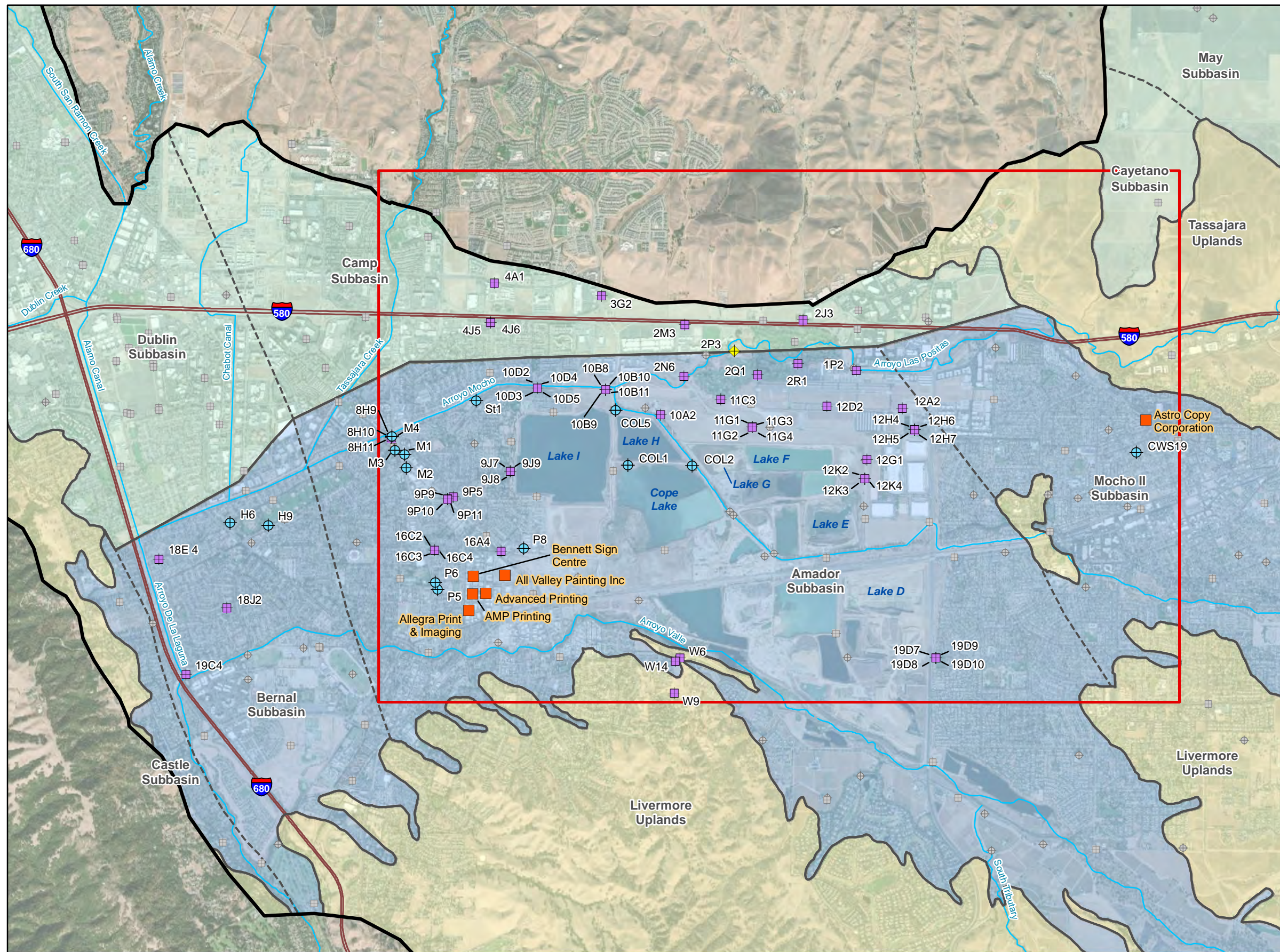


- Legend**
- Search Area
 - Manufacturing Facility
 - Monitoring Well
 - Municipal Well
- Wells with PFAS Data**
- Domestic Well
 - Monitoring Well
 - Municipal Well
- Livermore Valley Groundwater Basin
 - Main Basin Management Area and Subareas
 - Fringe Management Area and Subareas
 - Upland Management Area
 - Subbasin Boundary
 - Interstate
 - Stream

Basemap Source: Esri World Imagery



**Figure 16. Manufacturing Facilities
PFAS Potential Source Investigation
Zone 7 Water Agency**



Basemap Source: Esri World Imagery

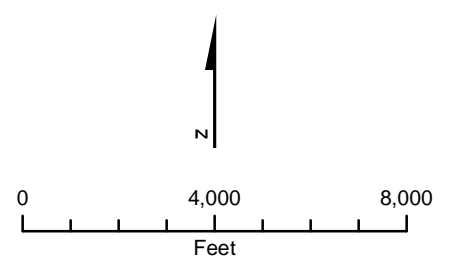
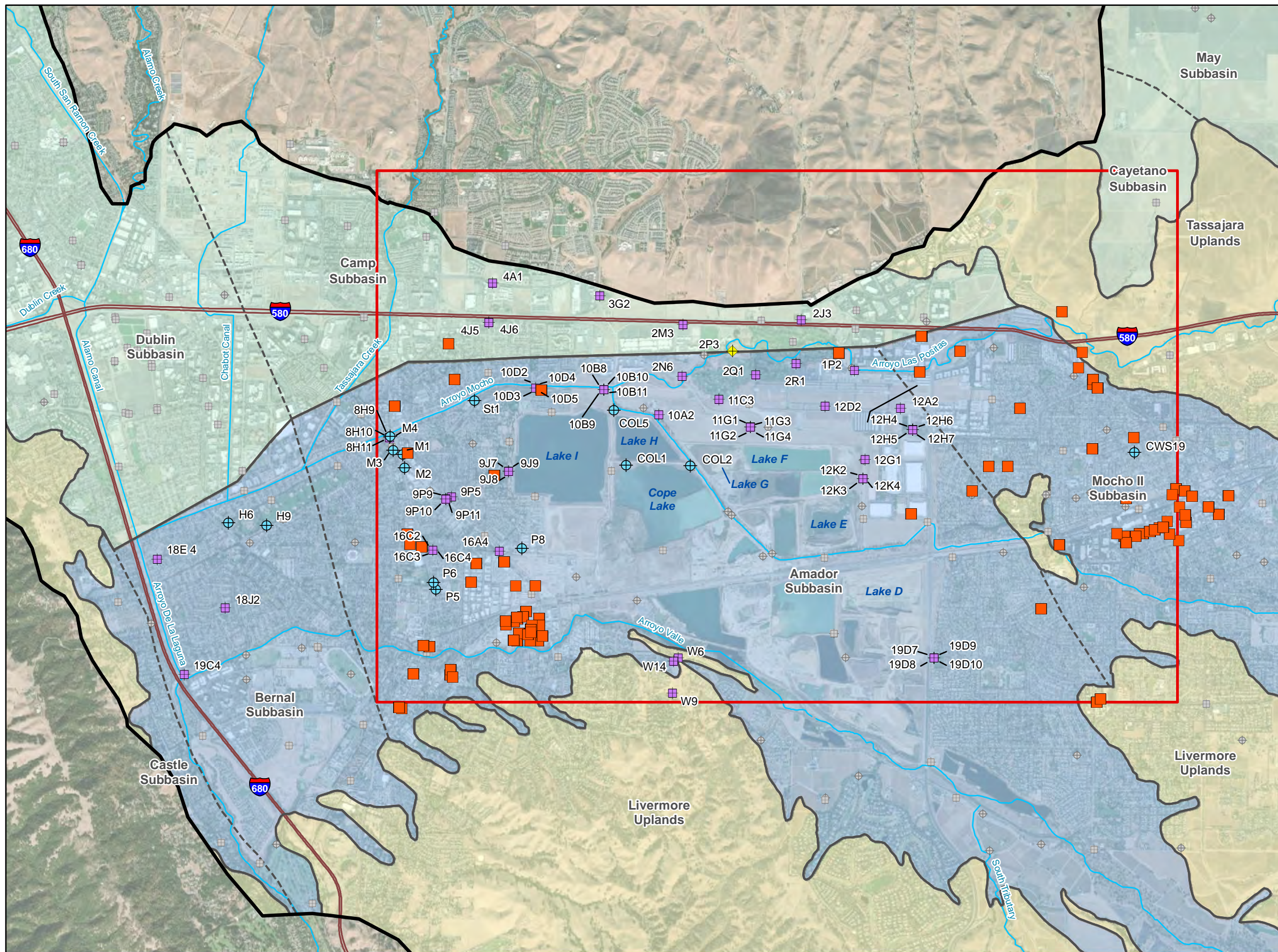


Figure 17. Printing Facilities
 PFAS Potential Source Investigation
 Zone 7 Water Agency

\\gal\proj\Zone_7\W8Y06500\MapFiles\Printing_200901.mxd



Legend

- Search Area
- Car Wash and Car Repair Facilities
- Monitoring Well
- Municipal Well

Wells with PFAS Data

- Domestic Well
- Monitoring Well
- Municipal Well

- Livermore Valley Groundwater Basin
- Main Basin Management Area and Subareas
- Fringe Management Area and Subareas
- Upland Management Area
- Subbasin Boundary
- Interstate
- Stream

Note:
 1) Only car wash and car repair facilities within 0.5-mile of municipal wells are shown.

Basemap Source: Esri World Imagery

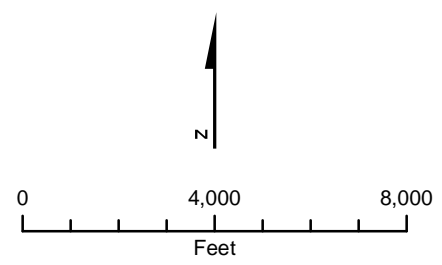
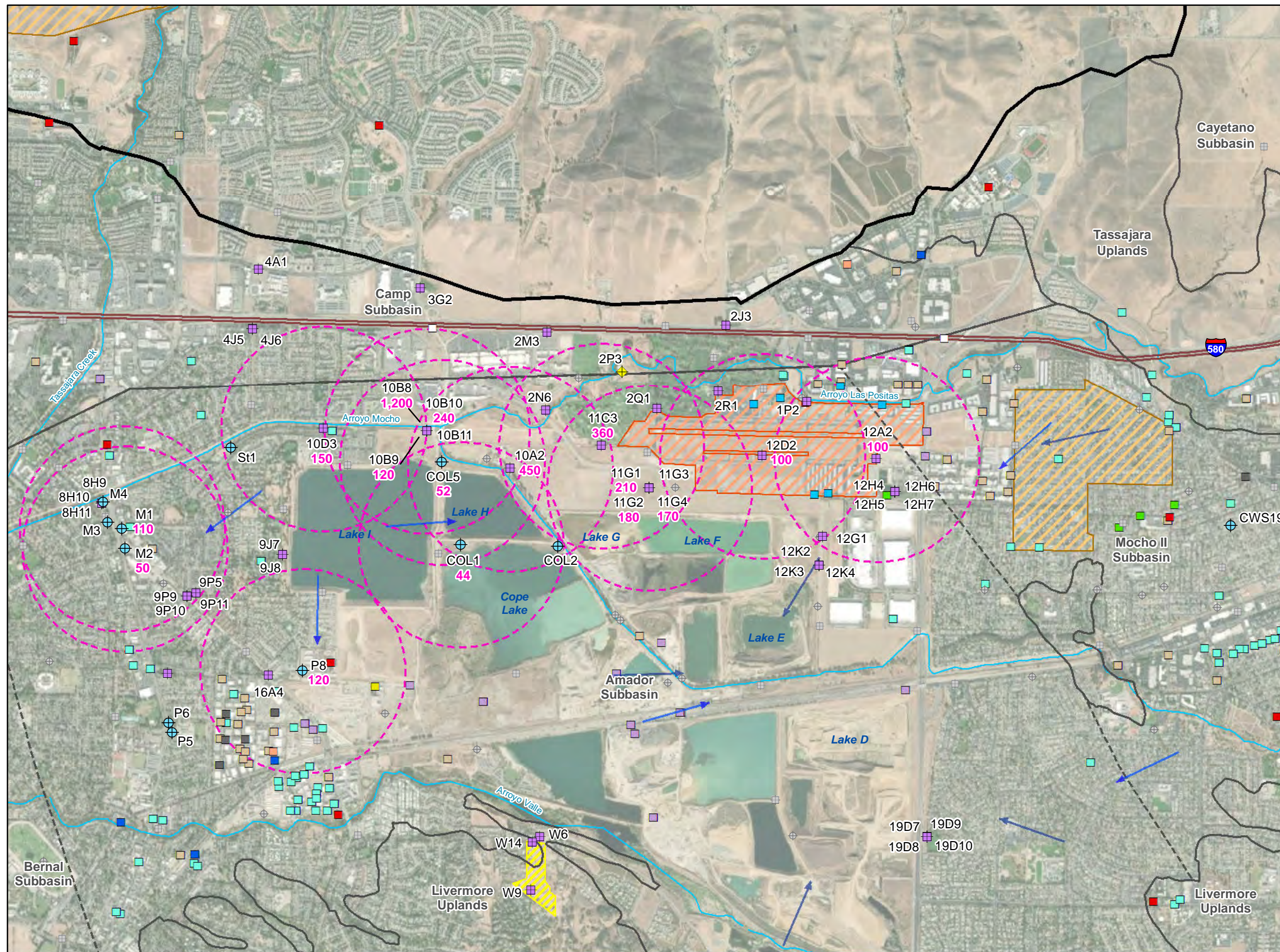


Figure 18. Car Wash and Car Repair Facilities
 PFAS Potential Source Investigation
 Zone 7 Water Agency



- Legend**
- Monitoring Well
 - ⊕ Municipal Well
 - Wells with PFAS Data**
 - ◆ Domestic Well
 - Monitoring Well
 - ⊕ Municipal Well
 - 0.5-mile radius around municipal well where PFOS has exceeded response level and monitoring well where PFOS has exceeded 100 ng/L
 - Groundwater Flow Direction (Lower Aquifer)
 - Groundwater Flow Direction (Upper Aquifer)
 - ▭ Livermore Valley Groundwater Basin
 - ▭ Management Area Boundary
 - - - Subbasin Boundary
 - Interstate
 - Stream
 - ▭ Livermore Municipal Airport
 - ▭ Military Facility
 - ▭ Old Pleasanton Landfill
 - Airports and Related Facilities
 - Car Wash and Car Repair Facilities
 - Cement Facility
 - Emergency Response Site
 - Fire Protection Facility
 - Fire Station
 - Landfills
 - Manufacturing Facility
 - Plating Facility
 - Printing Facility
 - Wastewater Treatment Facility

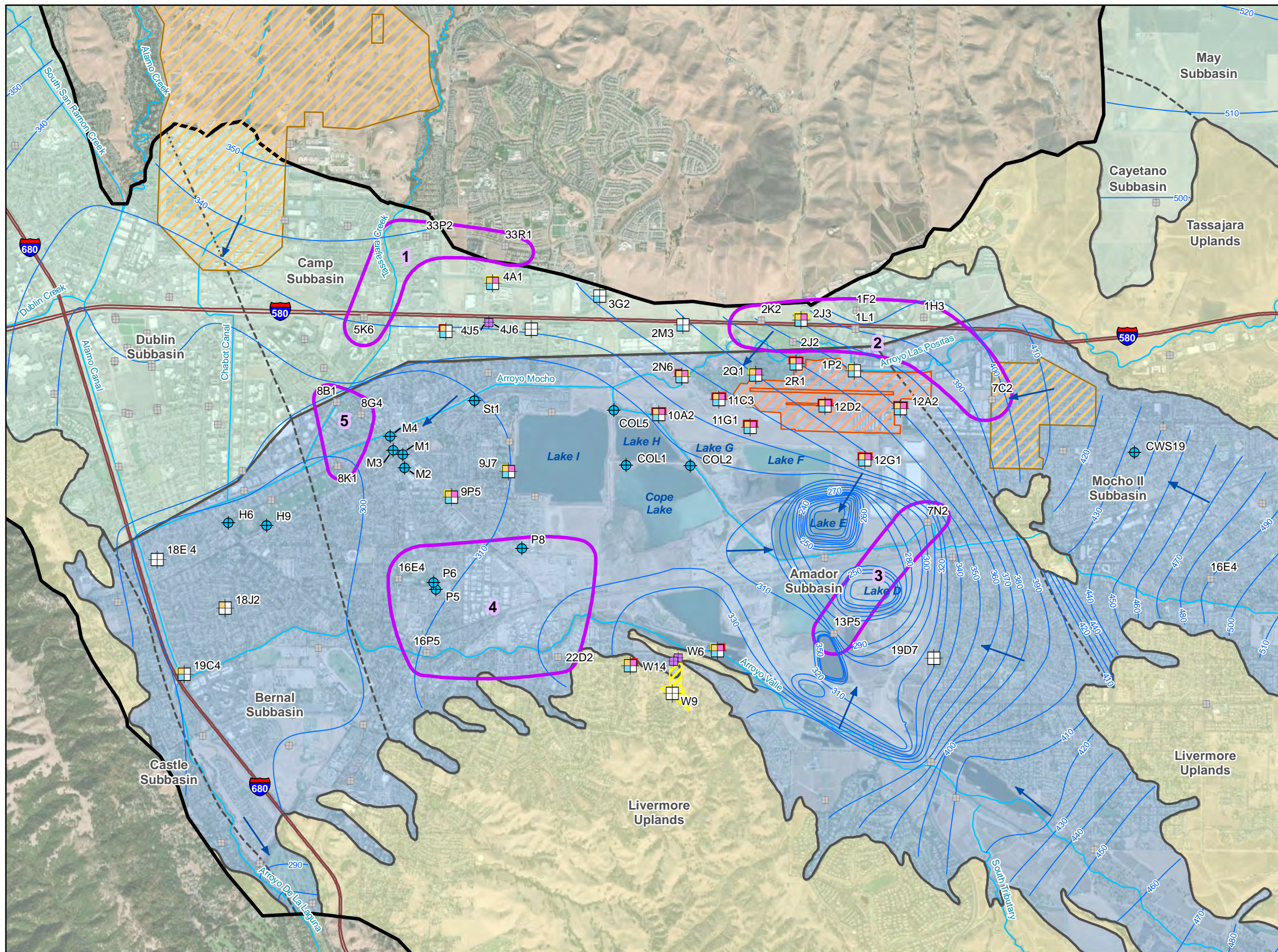
Basemap Source: Esri World Imagery

0 0.5 1
Miles

N

Figure 19. Comparison of Potential PFAS Sources to Distribution of PFOS
 PFAS Potential Source Investigation
 Zone 7 Water Agency

\\galt\proj\Zone_7\W8Y06500\MapFiles\PFAS_PFOS_Comparison_200918.mxd



- Legend**
- Recommended Locations for PFAS Sampling in Upper Aquifer
 - Monitoring Well*
 - Municipal Well
 - Other Upper Aquifer Monitoring Well
 - Groundwater Elevation Contour, Fall 2019 (feet above mean sea level)
 - Groundwater Flow Direction (Upper Aquifer)
 - Livermore Municipal Airport
 - Military Facility
 - Old Pleasanton Landfill
 - Livermore Valley Groundwater Basin
 - Main Basin Management Area and Subareas
 - Fringe Management Area and Subareas
 - Upland Management Area
 - Subbasin Boundary
 - Interstate
 - Stream

Basemap Source: Esri World Imagery

*Well Symbology:

Yellow Outline = Notification Level Exceeded	Red Outline = Response Level Exceeded
Orange Fill = PFOS Detected	Pink Fill = PFOA Detected
Blue Fill = Other of 7 PFAS Detected	

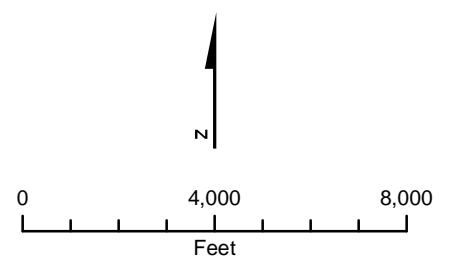
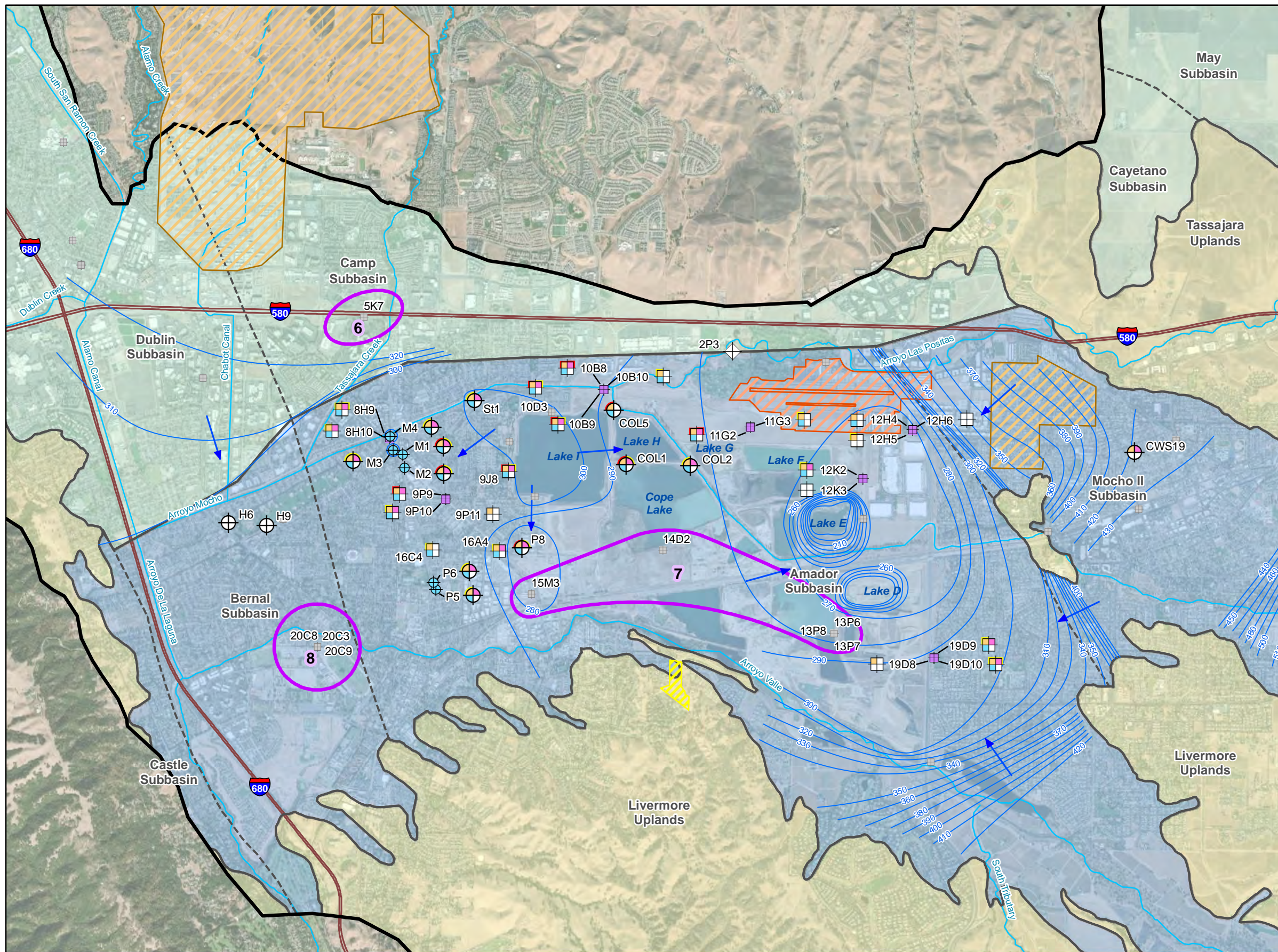


Figure 20. Recommended Locations for PFAS Sampling in Upper Aquifer
 PFAS Potential Source Investigation
 Zone 7 Water Agency



- Legend**
- Recommended Locations for PFAS Sampling in Lower Aquifer
 - ◆ Domestic Well*
 - Monitoring Well*
 - Municipal Well*
 - Other Lower Aquifer Monitoring Well
 - Groundwater Elevation Contour, Fall 2019 (feet above mean sea level)
 - Groundwater Flow Direction (Lower Aquifer)
 - Livermore Municipal Airport
 - Military Facility
 - Old Pleasanton Landfill
 - Livermore Valley Groundwater Basin
 - Main Basin Management Area and Subareas
 - Fringe Management Area and Subareas
 - Upland Management Area
 - Subbasin Boundary
 - Interstate
 - Stream

Basemap Source: Esri World Imagery

***Well Symbolology:**

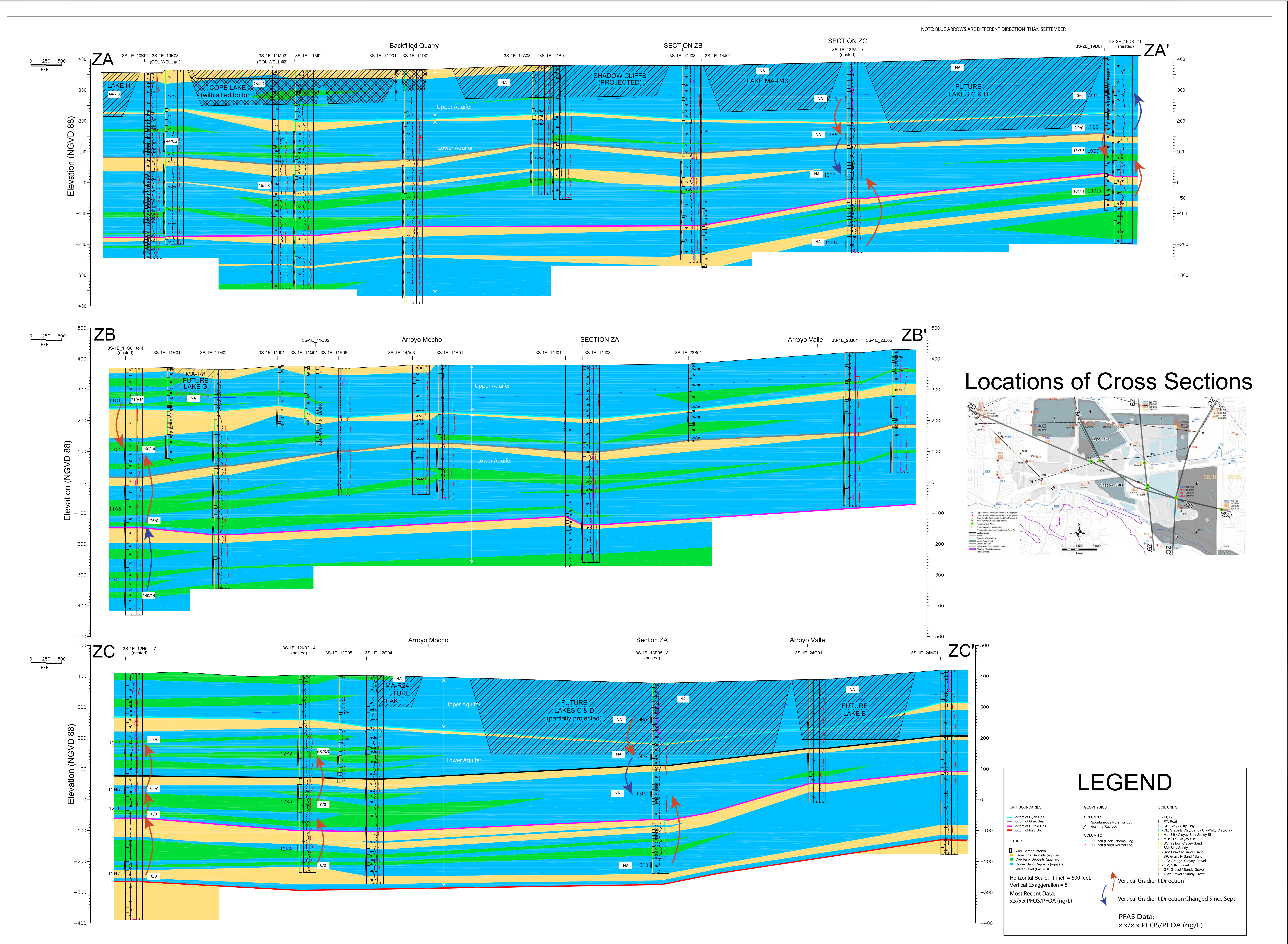
 Yellow Outline = Notification Level Exceeded	 Red Outline = Response Level Exceeded
 Orange Fill = PFOS Detected	 Pink Fill = PFOA Detected
 Blue Fill = Other of 7 PFAS Detected	

N

0 4,000 8,000
Feet

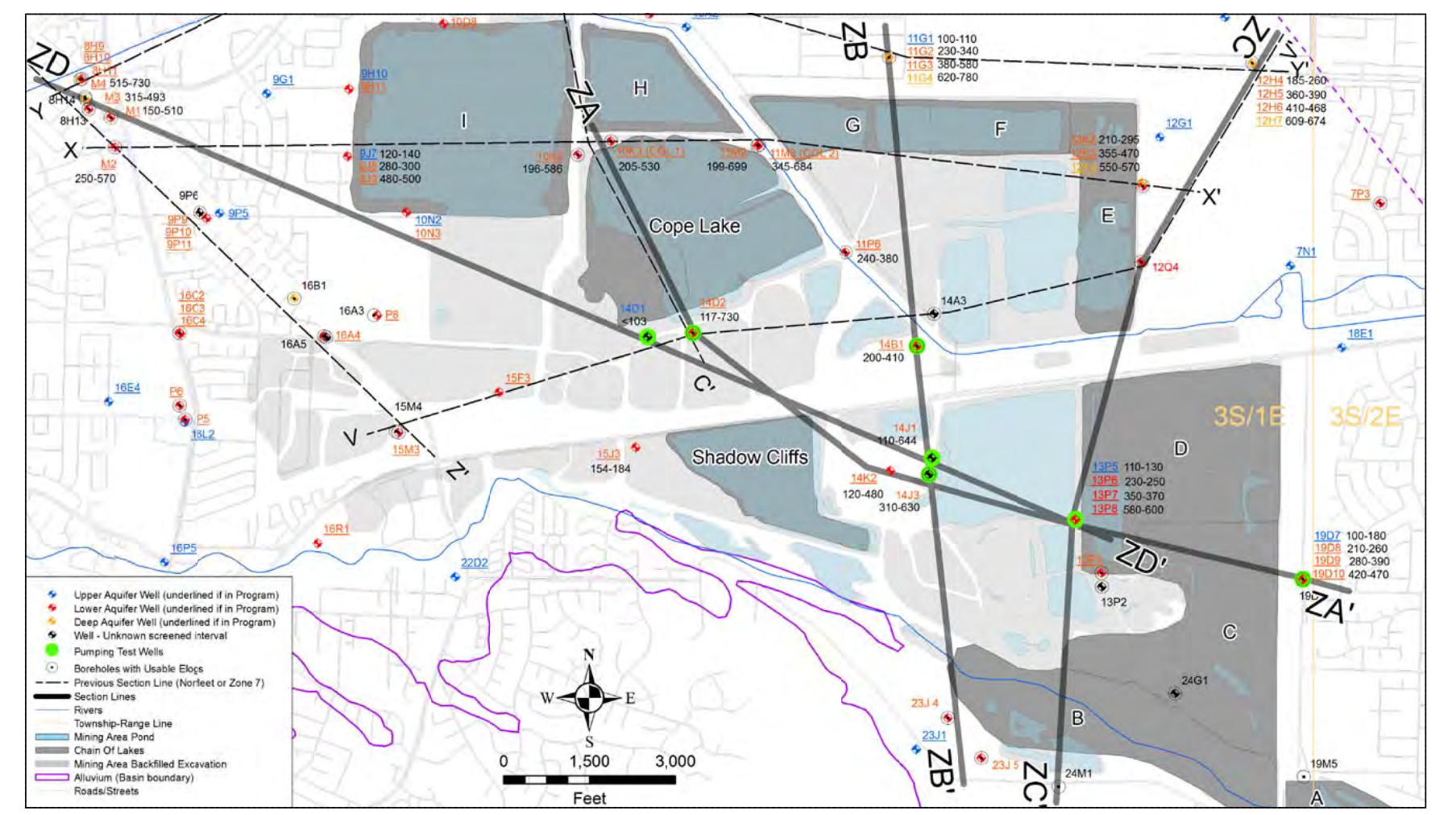
Figure 21. Recommended Locations for PFAS Sampling in Lower Aquifer
 PFAS Potential Source Investigation
 Zone 7 Water Agency

Attachment A
Zone 7 Cross-Sections



NOTE: BLUE ARROWS ARE DIFFERENT DIRECTION THAN SEPTEMBER

Locations of Cross Sections



LEGEND

UNIT BOUNDARIES - Bottom of Open Unit - Bottom of Gray Unit - Bottom of Purple Unit - Bottom of Red Unit OTHER - Well Screen Interval - Lenticular Deposits (aquifer) - Overbank Deposits (aquifer) - Gravel/Sand Deposits (aquifer) - Water Level (Fall 2010) Horizontal Scale: 1 inch = 500 feet. Vertical Exaggeration = 5 Most Recent Data: x.x/x.x PFOS/PFOA (ng/L)	GEOPHYSICS - Spontaneous Potential Log - Gamma Ray Log COLUMN 2 - 18 Inch (Short) Normal Log - 64 Inch (Long) Normal Log	SOIL UNITS - F-F: Fill - C-C: Clay / Silty Clay - CL: Clayey Clay/Sandy Clay/Silty Clay/Clay - ML: Silty Clayey Silt/Sandy Silt - ML: Silty Clayey Silt - SC: Yellow Clayey Sand - Silty Sandey - SW: Gravelly Sand / Sand - SP: Gravelly Sand / Sand - GC: Gravelly Clayey Gravel - CL: Silty Gravel - GP: Gravel / Sandy Gravel - CG: Gravel / Sandy Gravel
--	---	---

Vertical Gradient Direction
 Vertical Gradient Direction Changed Since Sept.
 PFAS Data:
 x.x/x.x PFOS/PFOA (ng/L)

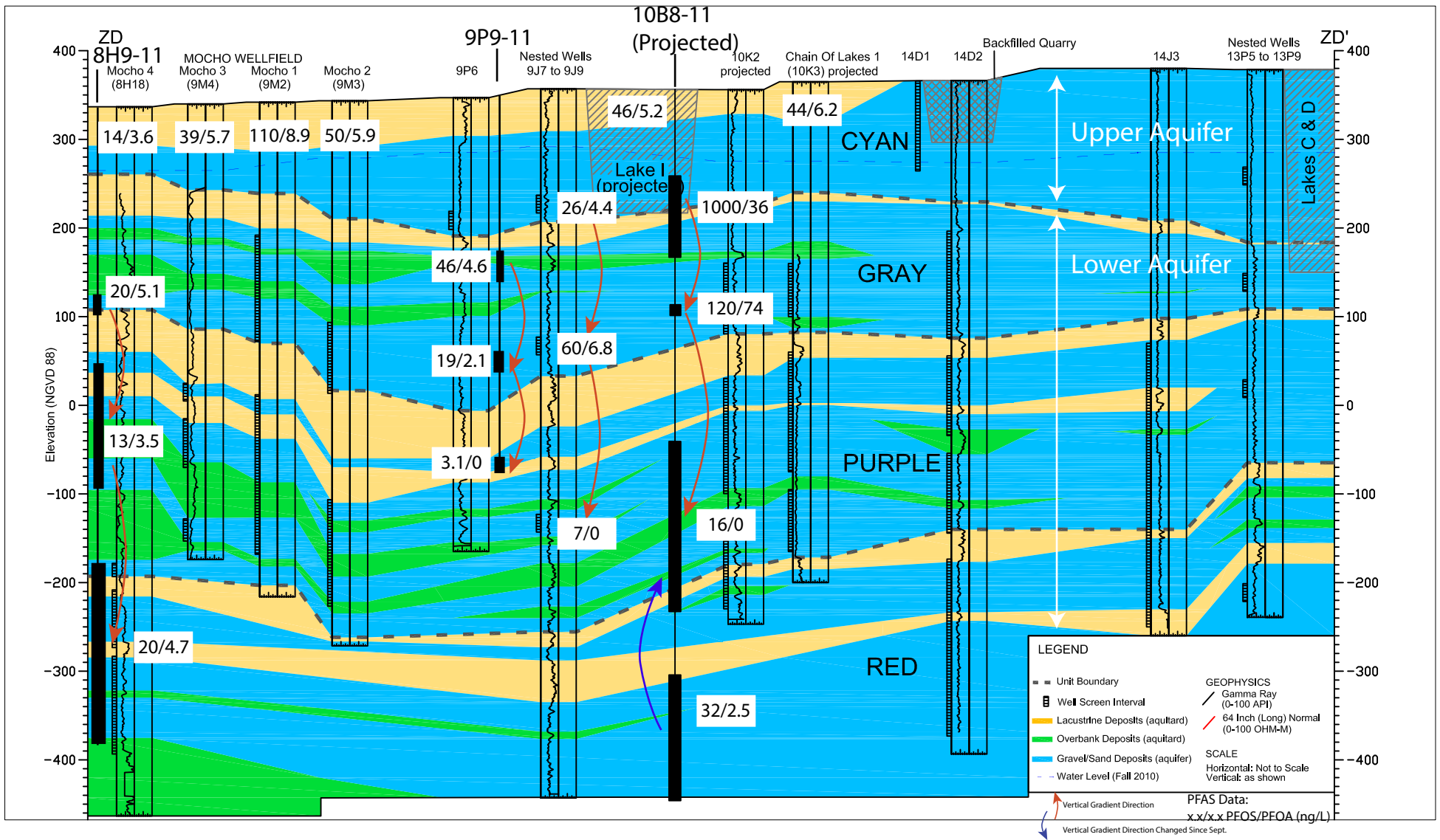


OWN:	TR	SCALE:	H: 1" = 500' V: 1" = 100'
PATH:		APPD:	
DATE:	3/19/11	REV:	

Cross Sections ZA to ZC

Vertical Flow Gradients

PROJECT:
Hydrostratigraphic Investigation
of the Aquifer Recharge Potential
For Lakes C and D
FIGURE NO.:
Attachment A-1



ZONE 7 WATER AGENCY
 100 NORTH CANYONS PKWY
 LIVERMORE, CA 94551

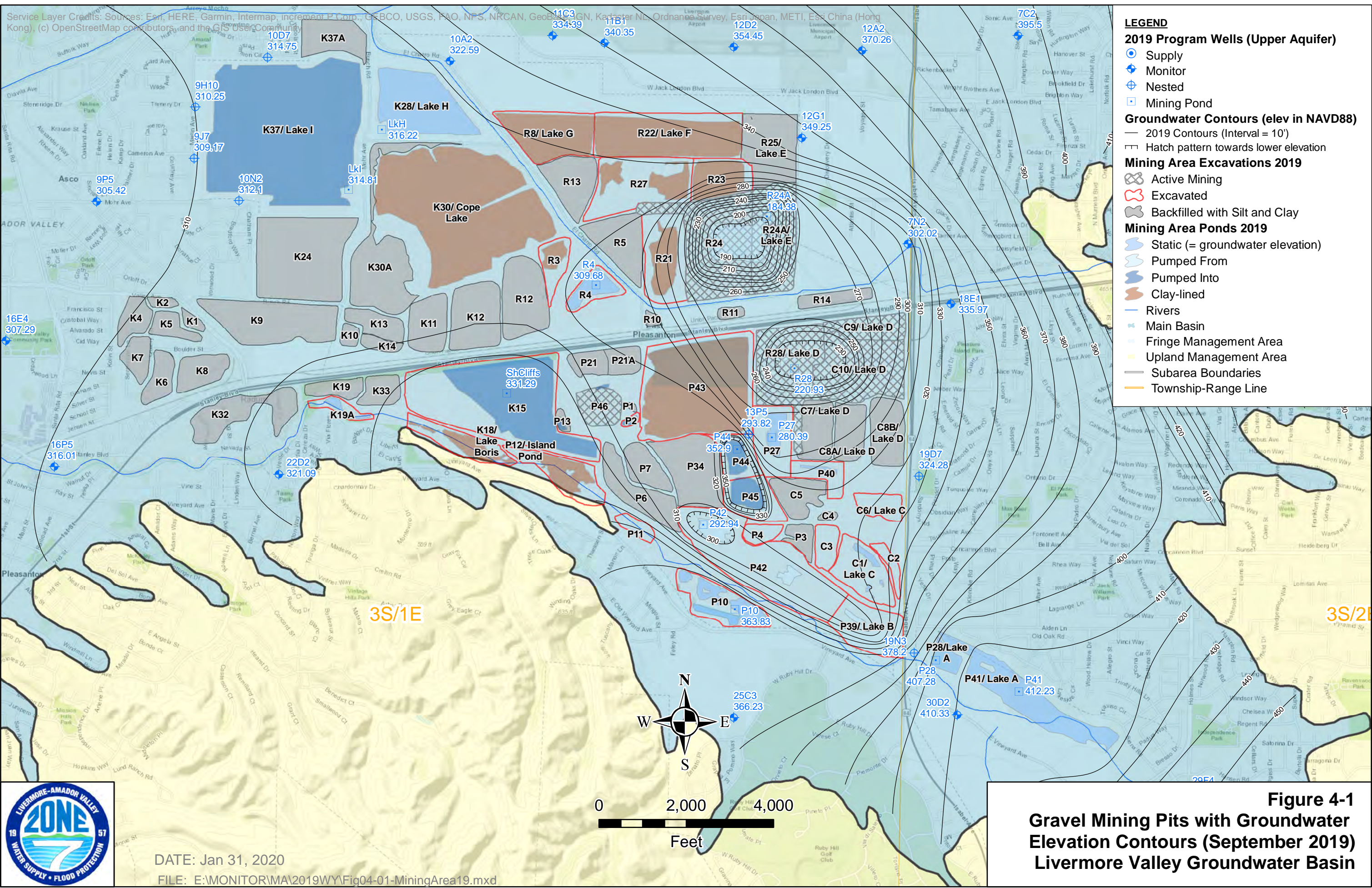
DWN: TR
 DES.: TR
 CHK: MK
 APPD: MK

SCALE: Horizontal: none; Vertical: 1" ~ 160'
 DATE: May 20, 2011
 FILE: E:\GISProg\Zone7\GeoSections\
 MainSections\Section-ZD.dwg

Vertical Flow Gradients
 Cross Section ZD

Attachment A-2

Attachment B
Figures from 2019 Annual Report



DATE: Jan 31, 2020
 FILE: E:\MONITOR\MA\2019WY\Fig04-01-MiningArea19.mxd

Service Layer Credits: Sources: Esri, HERE, Garmin, Intermap, increment P Corp., GEBCO, USGS, FAO, NPS, NRCAN, GeoBase, IGN, Kadaster NL, Ordnance Survey, Esri Japan, METI, Esri China (Hong Kong), (c) OpenStreetMap contributors, and the GIS User Community

ABBREVIATIONS FOR MUNI WELLS
 CWS= California Water Service
 M = Mocho (Zone 7)
 H = Hopyard (Zone 7)
 St = Stoneridge (Zone 7)
 P = Pleasanton
 SF = San Francisco Public Utilities Commission

LEGEND

Well Colors

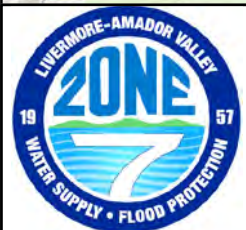
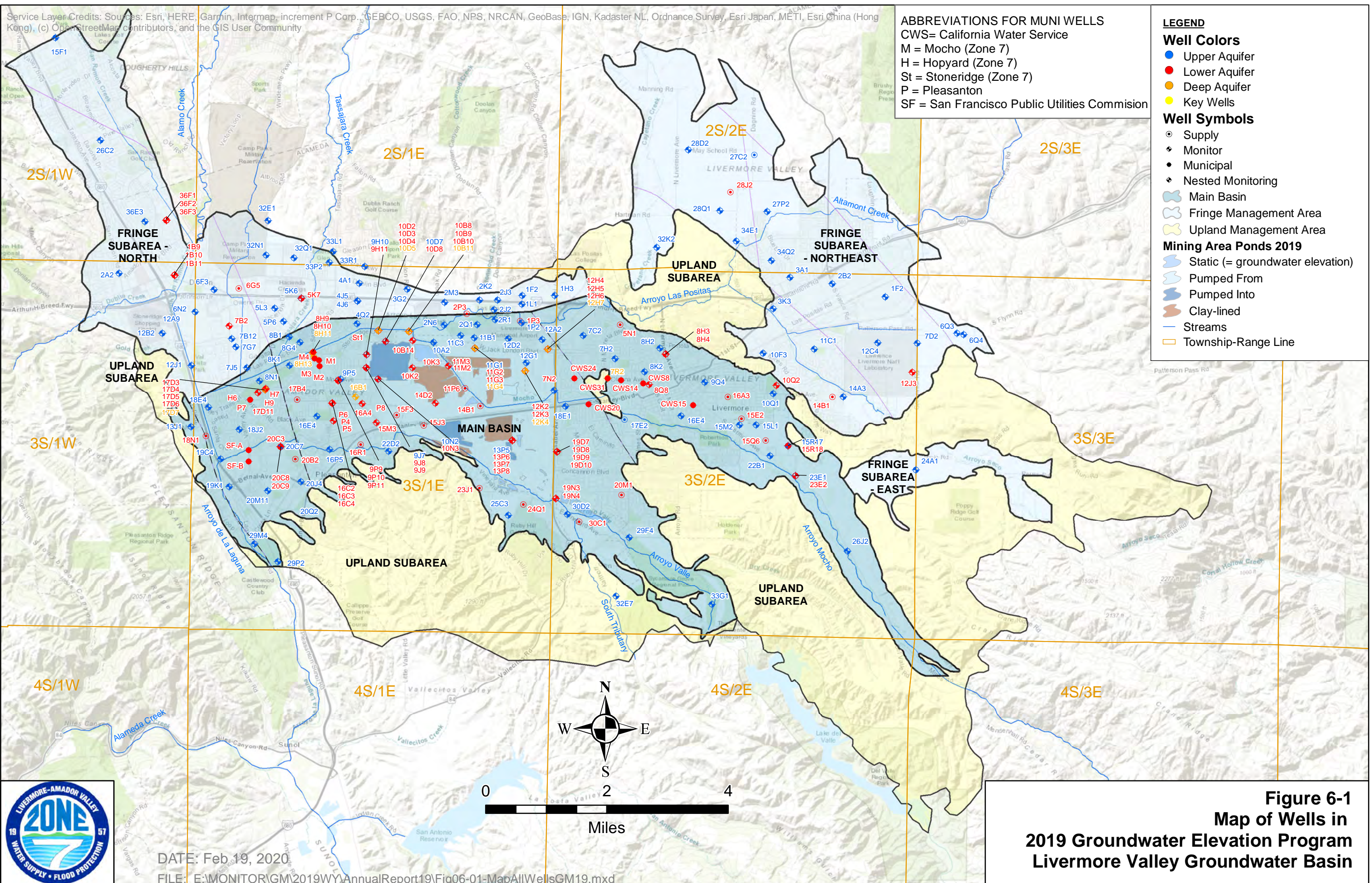
- Upper Aquifer
- Lower Aquifer
- Deep Aquifer
- Key Wells

Well Symbols

- Supply
- ◆ Monitor
- Municipal
- ◆ Nested Monitoring
- ☞ Main Basin
- ☞ Fringe Management Area
- ☞ Upland Management Area

Mining Area Ponds 2019

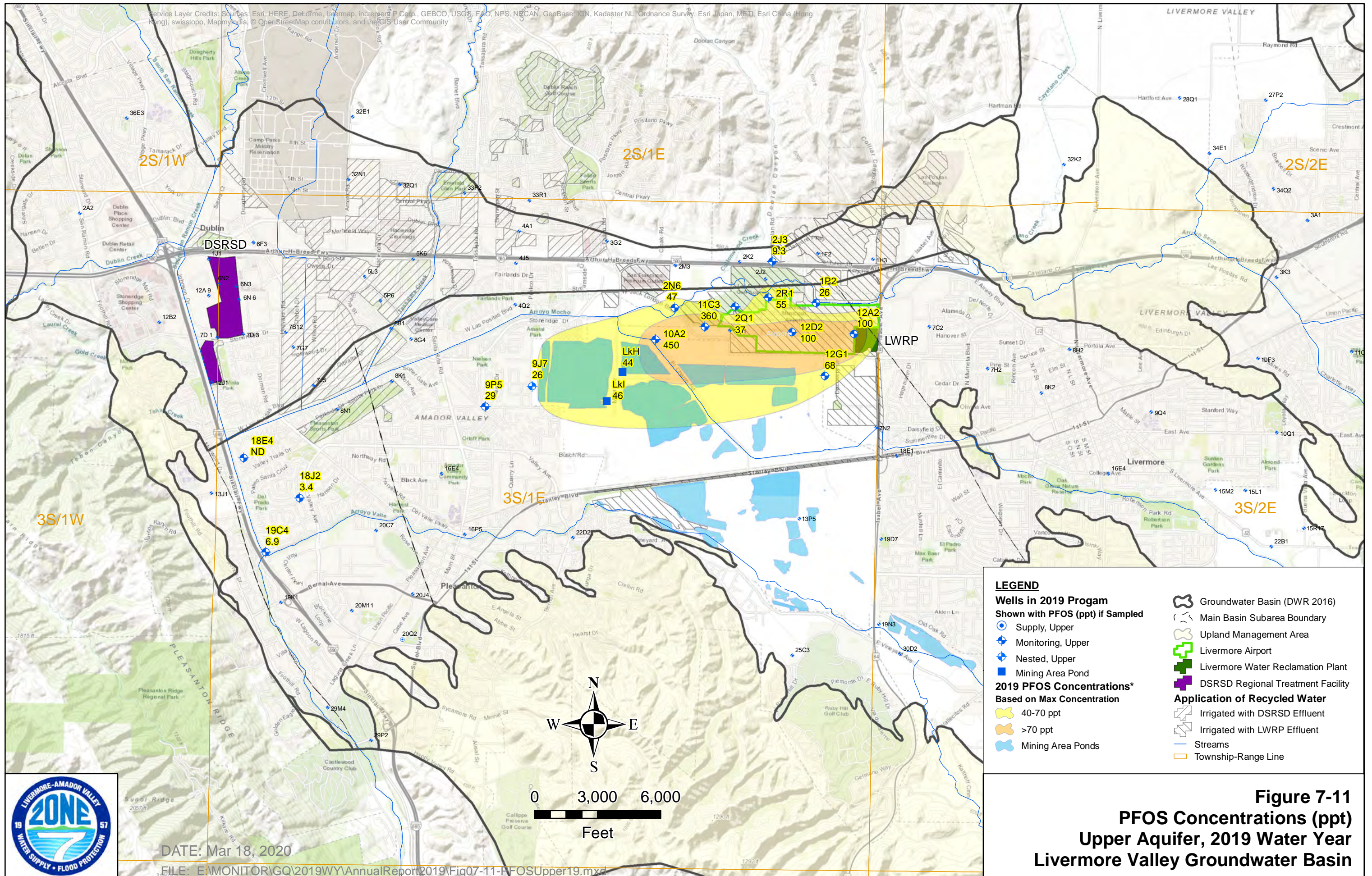
- ☞ Static (= groundwater elevation)
- ☞ Pumped From
- ☞ Pumped Into
- ☞ Clay-lined
- Streams
- Township-Range Line



DATE: Feb 19, 2020

FILE: E:\MONITOR\GM2019WY\AnnualReport19\Fig06-01-MapAllWellsGM19.mxd

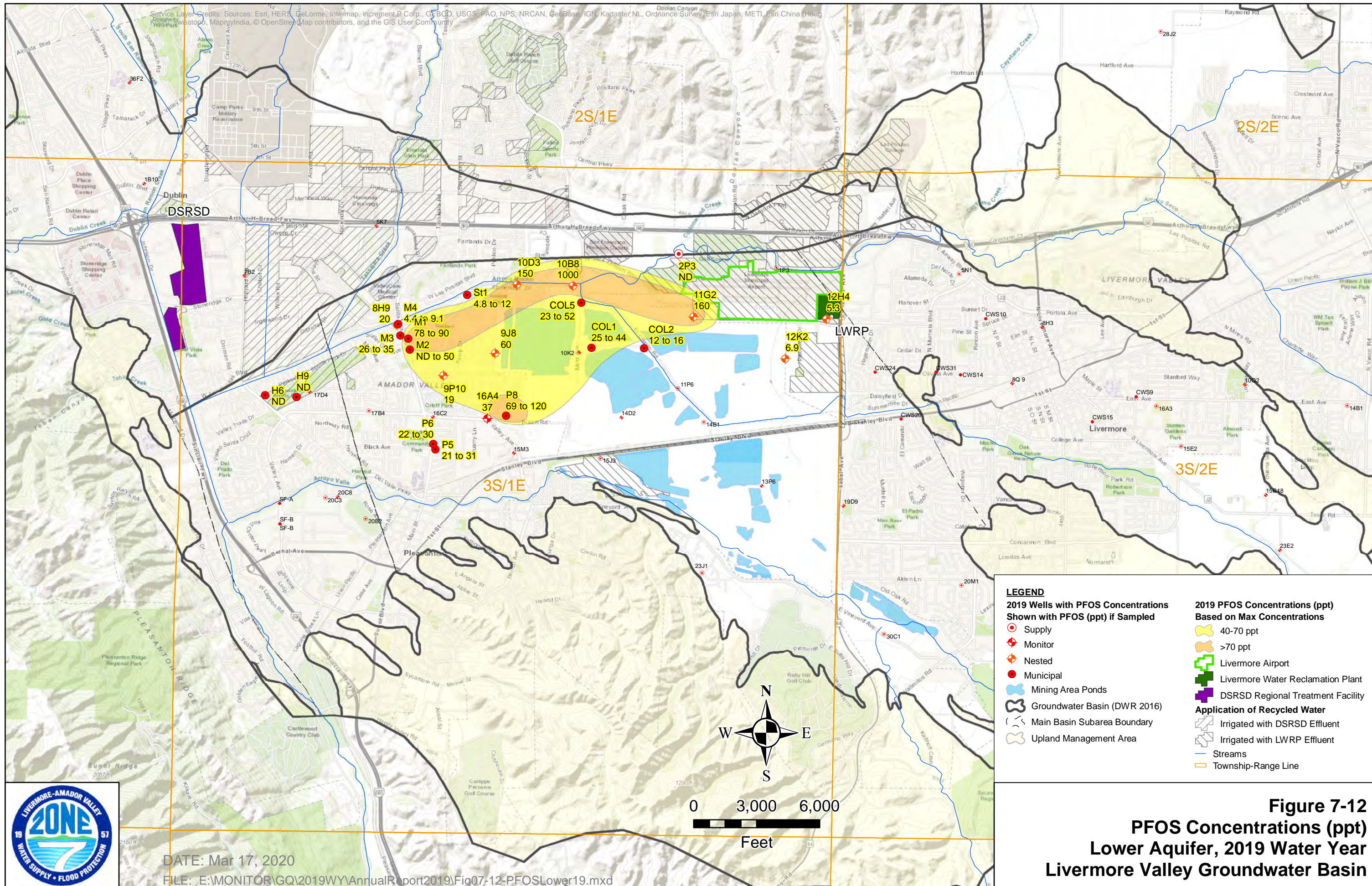
Figure 6-1
Map of Wells in
2019 Groundwater Elevation Program
Livermore Valley Groundwater Basin



DATE: Mar 18, 2020

FILE: E:\MONITOR\GQ\2019WY\AnnualReport\2019\Fig07-11-PFOSUpper19.mxd

Figure 7-11
PFOS Concentrations (ppt)
Upper Aquifer, 2019 Water Year
Livermore Valley Groundwater Basin



Attachment C
Environmental Data Resources (EDR) Report
(provided electronically)

**Attachment D
Database Searches
(provided electronically)**

Attachment E
Sample Questionnaire

PFAS Preliminary Assessment Questionnaire

Fire Chief or Designees

Name:	
Title:	
Date of Interview:	
Contact information (email/phone number):	

Note:

If you can recommend additional contacts that you feel may be able to provide additional information, please provide the name and as much contact information as you have. Thank you.

AFFF Purchasing, Handling, and Storage

1. Was perfluorinated AFFF historically or currently used within your jurisdiction? If so, provide any information regarding where and when.
2. To the best of your knowledge, where has the AFFF solution been handled (currently and historically) (such as mixed, contained, released for calibration, transferred)?
3. Where is AFFF and AFFF equipment stored (currently and historically), and in what approximate quantities? (Please show locations on map provided or describe locations).
 - a. Please describe procedures for how AFFF equipment is cleaned/decontaminated.
What is the fate of wash water for fire trucks with AFFF on them as well as AFFF equipment wash?
 - b. To the best of your knowledge, where has the equipment currently or formerly been maintained?

Firefighting Training Areas

1. As part historical or current operational training, are any current or historical Firefighting Training Areas (FTAs) present? If yes, please show the location/s of the FTAs on the map provided.
2. Has fire training or spray testing been done at areas not specifically designated as FTAs?
3. To the best of your knowledge, what are/were the years of operation for each FTA you identified in your answer to Question #1 above?

4. How many FTAs are currently active? Inactive (historical in nature)? To the extent possible, please specify which are active versus historical.
5. To the best of your knowledge, were fuels/flammables other than “typical” (such as JP-5, #2 Fuel Oil) used at the FTAs? If yes, what was used?
6. When AFFF was used during a fire training exercise, to the best of your knowledge, was the AFFF used contained and disposed, and if so, how was the AFFF cleaned up and disposed?
7. To the best of your knowledge, are current and historical FTAs lined? If so, with anything other than concrete?

Hangars and Buildings

1. Does the fire department respond to the municipal airport?
2. To the best of your knowledge, are there areas (such as hangars, buildings, fuel or hazardous waste storage areas) which historically had or currently have automated and/or manually-activated AFFF fire suppression systems?
3. To the best of your knowledge, please describe the procedure on how the suppression systems are supplied with AFFF (that is, is system contained within the building, or are there separate buildings that serve to mix AFFF to supply one or more hangers with suppression systems).
These systems often have testing or accidental system activation (triggered by an improperly ventilated vehicle coming in, for example) – Has the department had to respond to a call like this based on an existing agreement?
4. When the fire suppression system engages/or engaged, what is the current, and if different, historical response process for addressing AFFF used (that is, was AFFF cleaned up after being used and how)?
5. To the best of your knowledge, have there been inadvertent releases of AFFF from fire suppression systems (such as equipment failure)? If so, please provide additional details (such as when, in which hangars/buildings, could the release be quantified, was the release removed or cleaned up)?
6. To the best of your knowledge, for any historical activation (accidental, testing, or in response to an emergency) of AFFF systems within buildings, provide any information regarding the fate of the release (that is, did releases occur near drainage swales; were they washed to a pervious surface; did they occur on poorly maintained pervious surfaces [cracked concrete, porous asphalt]; were they directed to a storm drain, trench drain, oil/water separator [OWS], wastewater treatment plant).

Trucks and Trailers

1. Provide a list of current and historical parking/storage areas for AFFF equipment.
2. To the best of your knowledge, were the trucks currently and historically tested for spray patterns to make sure equipment is working properly? If so, how often and where are/were these spray tests performed?
3. To the best of your knowledge, what is the procedure on how trucks and trailers are/were supplied with AFFF?
 - a. Where does/did this resupply occur?
 - b. Is/was there secondary containment in this area?
 - c. What happens to the empty AFFF?
 - d. Containers?
4. Which foam varieties are used? Are cut sheets available?
5. To the best of your knowledge, what is the procedure for how these vehicles are/were cleaned, and where is/was vehicle cleaning performed (currently as well as historically)?

Records, Spill logs, Historical Information

1. To the best of your knowledge, are there any current or historical data/documents/records associated with AFFF that we may review/copy (such as reports/work plans, historical or operational records, incident reports, crash data, inspection reports, AFFF spill logs, documentation of AFFF releases, photo interpretation)?
In the absence of AFFF-specific records, does the department have incidents correlated to events that can be classified as Class B/alcohol-resistant foam usage (airfields, tank farm, fuel fires)?
2. Do you have recollection or records of AFFF being used in response to the following?
 - a. Fuel releases to prevent fires
 - b. Emergency response sites (such as plane, helicopter, or vehicle crash sites and fires)
 - c. Emergency runway landings where foam might have been used as a precaution
 - d. Other (such as air show demonstrations, AFFF “salutes”)

3. If yes to #2, please provide any information you have regarding how and if the releases were addressed and how any released material (including foam and contaminated soil) was disposed?

4. In the potential absence of written records or incomplete written records, can you provide anecdotal/verbal information and locations of spills or other emergency response incidents where AFFF was used that haven't already been previously discussed?

5. What are the current and historical storage location(s) of the wreckage from emergency response incidents (if wreckage is stored outside)?

Location Information

1. If not already covered in previous questions, please provide any information on releases of AFFF that may have been diverted to or could have impacted the following items/areas:
 - a. Stormwater conveyances/outfalls that drain runways, taxiways, and aprons

 - b. Stormwater management system (such as drainage swales, outfalls, retention/detention basins)

 - c. Industrial or sanitary wastewater treatment system (such as storm drain, sanitary sewer, OWS, building and plumbing drains)

 - d. Water supply wells (such as potable, agricultural, industrial)

 - e. Large-scale disposal (such as landfilling, land application of WWTP sludge, washing, dumping)

 - f. Other

General Information

1. Is there anyone else that you would recommend we interview? Name, organization, position, phone number, e-mail.

Other Notes

Attachment F
Telephone Conversation Summaries

2600 Michelson Drive, Suite 500
Irvine, California 92612
United States
T +1.949.224.7500
F +1.949.224.7501
www.jacobs.com

Subject: Call to Alameda County Fire Department (ACFD)
Client: Zone 7 Water Agency **Date:** September 22, 2020
Project: PFAS Potential Source Investigation
Prepared by: Jenny Reina/Jacobs
Participants: Anonymous Firefighter from Fire Station 18

Notes

The firefighter shared the following with me:

About Fire Station 18

- This fire station has an engine company, one patrol and a bulldozer. Its response area covers the eastern most portions of Dublin and is primarily responsible for residential, high density housing, urban wildland interface areas and Highway 580. It became operational July 2003.
- Asked if Fire Station 18 has the special equipment needed to respond to fire emergencies at the Livermore Airport. He explained that they do not have the ARFF apparatus, and to the best of his knowledge none of the county stations have it. He believes that the main responder to a fire emergency at the airport is the Oakland Fire Department.

Foam Use

- Fire station has two fire trucks (one large type 1 and one small type 3, and one patrol vehicle). The two trucks have the equipment needed to handle foams.
- Fire Station 18 mostly uses Class A and Class B foams.
- AFFF is still available at some stations.
- No knowledge of AFFF spills.

Equipment Testing/Maintenance

- Small nozzle testing activities can be done at Fire Station 18. However, most maintenance activities are done at the regional vehicle maintenance facility.
- Asked if this regional facility provides vehicle maintenance services for the LPPFD. He said that it depends on the work needed and he thinks for significant repairs, it is likely that the facility would have provided services to LPPFD. The facility also services fire stations from other cities in the county.
- Trucks are normally parked and cleaned at the fire station.

Note: an attempt was made to contact the regional maintenance facility and staff declined to provide any information.

2600 Michelson Drive, Suite 500
Irvine, California 92612
United States
T +1.949.224.7500
F +1.949.224.7501
www.jacobs.com

Subject: Call to Las Positas College

Client: Zone 7 Water Agency **Date:** September 22, 2020

Project: PFAS Potential Source Investigation

Prepared by: Jenny Reina/Jacobs

Participants: German Sierra, Fire Service Technology Faculty-Coordinator

Notes

German shared the following information with me:

Training

- Currently they don't do in person training at the academy. Only virtual simulations.
- When asked if they had done any training in the past, pre-Covid or perhaps before AFFF was banned he replied that they have never done any training with foam. He said they have used a mix of kool-aid and water but they had to stop that practice because the water conservation regulations don't allow them to use drinking water. German also explained that they considered using the recycled water fire hydrant on the property, but they had to stop because the recycled water available is not potable.

About the Firefighter Academy

- He didn't know how long the academy has been in operation. German has been there only for 2 years.
- From the website: "Our Firefighter 1 Academy is offered through partnerships with the Livermore-Pleasanton Fire Department utilizing personnel from Fire Agencies throughout Alameda County."

I asked if this means that they perhaps do training at the LPFS training center since they can do any training at the college. He said they don't do any training with the LPFD and don't have any joint operations.

Equipment Testing/Maintenance

- Any questions on equipment testing, calibration or maintenance need to be discussed with the operations and administration staff. German said he will figure out who is the right person to talk to and pass my contact information to them and asked them to call me.
- Suggested contacting the Alameda County Fire Department and vehicle maintenance facility.
- Suggested contacting the Oakland Fire Department.

2600 Michelson Drive, Suite 500
Irvine, California 92612
United States
T +1.949.224.7500
F +1.949.224.7501
www.jacobs.com

Subject: Call to Livermore-Pleasanton Fire Department (LPPFD)
Client: Zone 7 Water Agency **Date:** September 22, 2020
Project: PFAS Potential Source Investigation
Prepared by: Jenny Reina/Jacobs
Participants: Aaron Lacey, Deputy Chief at LPPFD

Notes

Deputy Chief Lacey returned my call and we talked briefly about general practices and use of AFFF and Class B foam. This is what he shared with me:

AFFF/Foam Use (historical and current)

- Used AFFF about 10 years ago. Now they use eco-friendly foams.
- LPPFD have Class B foam stored at Station 10 at the airport and still use it for fire suppression systems and fire emergencies.
- LPPFD doesn't own equipment necessary to manage fire emergencies at the airport only fire engines.
- For airport emergencies they would use Class B foam as the trucks are set up for this.

Training

- Not associated with Las Positas College Fire Academy. The academy does training for foam use but LPPFD do not do training for them.
- Training for Department staff is at the LPPFD owned training facility only.
- They don't use foam at shows or demonstrations anymore.

Spills and Emergencies

- To his knowledge there are no records of Class B foam spills. Foam is not used if runoff from the impacted area could reach creeks, lakes or other natural water systems.

At the end of the conversation he noted: Any additional questions or questionnaire will have to be discussed with the legal department. "LPPFD doesn't own the buildings, these are owned by City and the legal department will have to review the questionnaire before they can respond."

Attachment G
PFAS Sampling at Pleasanton Landfill



October 10, 2019

Mr. Keith Roberson
California Regional Water Quality Control Board
San Francisco Bay Region (SFRWQCB)
1515 Clay Street, Suite 1400
Oakland, CA 94612

**RE: REPORT OF FINDINGS FOR ONE-TIME LEACHATE AND GROUNDWATER
ASSESSMENT OF PER- AND POLYFLUOROALKYL SUBSTANCES (PFAS)
OLD PLEASANTON LANDFILL, PLEASANTON, CALIFORNIA
EBA Job No. 97-609 (Task 5)**

Dear Mr. Roberson:

This report has been prepared on behalf of Pleasanton Garbage Service, Inc. (PGSI), owner and operator of the Old Pleasanton Landfill (Landfill) located at 2512 Vineyard Avenue in Pleasanton, California (see Figure 1, Appendix A), to report the results of PFAS sampling performed at the Landfill on August 20, 2019. The work was performed to comply with Order WQ 2019-0006-DWQ (Order) and was implemented in general accordance with EBA Engineering's (EBA's) *Work Plan for One-Time Leachate and Groundwater Assessment of Per- and Polyfluoroalkyl Substances (Work Plan)* dated May 14, 2019. The SFRWQCB approved the Work Plan in an email dated July 31, 2019. The following sections outline the scope of work performed and a summary of the results. Supporting documentation including a site map, copies of field sampling data forms, tabulated summary of the analytical data, and copies of the Certified Analytical Report (CAR) and chain-of-custody (COC) record are enclosed as appendices.

SCOPE OF WORK

Sample Locations

In accordance with the approved Work Plan, groundwater sampling for the PFAS assessment was performed on selected monitoring wells associated with an existing groundwater monitoring well network that consists of 16 monitoring wells located at various locations around the perimeter of the waste management unit (WMU). The locations of the monitoring wells are shown on Figure 2 (Appendix A). Based on results

from historical monitoring, three monitoring wells were targeted as part of the PFAS assessment. The selected monitoring wells and corresponding rationale are summarized as follows:

Monitoring Well W-9

This monitoring well is located near the hydraulically upgradient edge of the WMU and has exhibited no historical impacts. The water chemistry of W-9 has also been generally stable over the course of the monitoring program. Based on this circumstance, W-9 was identified as a suitable background sample point.

Monitoring Well W-6

Monitoring well W-6 is located hydraulically downgradient of the WMU and has exhibited both inorganic and volatile organic compound (VOC) impacts since the inception of the Landfill's monitoring program in 1998, thereby making it a suitable candidate for assessing the potential presence of PFAS.

Monitoring Well W-14

Similar to W-6, W-14 is located hydraulically downgradient of the WMU and is approximately 160 feet northwest of W-6 (see Figure 2, Appendix A). While the historical database for W-14 is not as extensive as W-6 (W-14 was installed in 2001), the water chemistry characteristics are similar, including the presence of both inorganic and VOC impacts. As such, W-14 was deemed appropriate for assessing the potential presence of PFAS.

The WMU is not equipped with a traditional leachate collection and removal system (LCRS), nor is leachate monitoring required as part of the Landfill's Waste Discharge Requirements Order No. R2-2002-0041. Based on these circumstances, leachate sampling for PFAS was not included in the PFAS assessment.

Sample Collection

The groundwater samples collected from W-6, W-9, and W-14 were obtained using Waterra high-density polyethylene (HDPE) inertial pumps (dedicated to each monitoring well) that consist of a one-way foot valve connected to a HDPE riser tube that was operated using a portable actuator installed on the wellhead. The HDPE composition of the pump/tubing materials served to minimize the potential for PFAS contamination related to the sampling process. The various precautionary measures as described in the Work Plan were also employed. Prior to sampling, standing water in the casing and gravel pack were purged from each monitoring well using the inertial pump as described above. Purging continued until the final two sets of stabilization readings (pH, specific conductance, temperature, and turbidity) as measured using calibrated portable meters met the following criteria:

- pH: ± 0.1 pH units
- Specific Conductance: ± 10 percent
- Temperature: $\pm 1.0^\circ$ Celsius
- Turbidity: ± 10 nephelometric turbidity units (NTU)

All field measurements were recorded on a field sampling data forms. Copies of the field sampling data forms are enclosed in Appendix B.

Upon completion of the purging process, samples retained for chemical analysis were transferred directly into 250 milliliter (ml) HDPE containers equipped with unlined plastic screw caps. Two containers were collected at each sample location. The sample containers were labeled using standard paper labels (not waterproof paper) and the information recorded using a ball-point pen (not felt pen or magic marker). Each sample set was placed inside a zip-lock plastic bag prior to placement inside a cooled ice chest.

A field reagent blank (FRB) was also collected using laboratory-certified PFAS-free water as a quality assurance/quality control (QA/QC) provision to check for potential ambient PFAS cross-contamination. The FRB sample was collected at the location of W-6.

Sample Preservation, Transport, and Documentation

All sample sets were placed in a cooled ice chest for transport to the laboratory. Standard bagged ice was used as the cooling agent. The bagged ice was double-bagged as a precautionary measure to ensure that any melt water didn't come into contact with the sample containers. The samples were hand delivered to Eurofins TestAmerica's (ETA's) facility located in Pleasanton, California. ETA's Pleasanton facility, in turn, shipped the samples to their Sacramento office where the PFAS testing services were performed. Proper COC protocols were followed to document the handling and transportation of the samples.

It should be noted that the type of sample containers recorded on the COC is identified as "polys". As a point of clarification and as described earlier in this section, the sample containers were HDPE.

Laboratory Testing

The groundwater and FRB samples were tested in the laboratory by Method EPA 537 Modified. The analyte list encompassed the 23 required PFAS analytes outlined in the State Water Resources Control Board (SWRCB) Table 1 and also included the analysis for perfluorononanesulfonic acid (PFNS) which is an encouraged analyte included in Table 1. The testing complied with the QA/QC requirements specified in Table B-15 of the Department of Defense Quality Systems Manual.

RESULTS

Results from the laboratory testing reveal the detection of miscellaneous PFAS in W-6 and W-14 (downgradient monitoring wells), whereas no PFAS were detected in the sample collected from W-9 (upgradient monitoring well) or the FRB sample. The following table provides a summary of the detections. Please refer to Appendix C for a complete tabulated summary for each of the respective samples.

SUMMARY OF PFAS DETECTIONS OLD PLEASANTON LANDFILL AUGUST 20, 2019		
Analyte	Monitoring Well W-6 (ng/L)	Monitoring Well W-14 (ng/L)
Perfluorobutanoic Acid (PFBA)	23	16
Perfluoropentanoic Acid (PFPeA)	3.7	4.1
Perfluorohexanoic Acid (PFHxA)	3.4	4.8
Perfluoroheptanoic Acid (PFHpA)	4.8	4.6
Perfluorooctanoic Acid (PFOA)	37	29
Perfluorobutanesulfonic Acid (PFBS)	8.3	9.2
Perfluoropentanesulfonic Acid (PFPeS)	3.3	3.7
Perfluorohexanesulfonic Acid (PFHxS)	5.8	6.2
Perfluorooctanesulfonic Acid (PFOS)	12	7.4

PFAS: Per- and Polyfluoroalkyl Substances
ng/L: Nanograms per Liter

Please refer to Appendix D for a copy of the CAR and associated COC record.

CLOSING

If you should have any questions regarding the information contained herein, please do not hesitate to contact our office at (707) 544-0784.

Regards,
EBA ENGINEERING



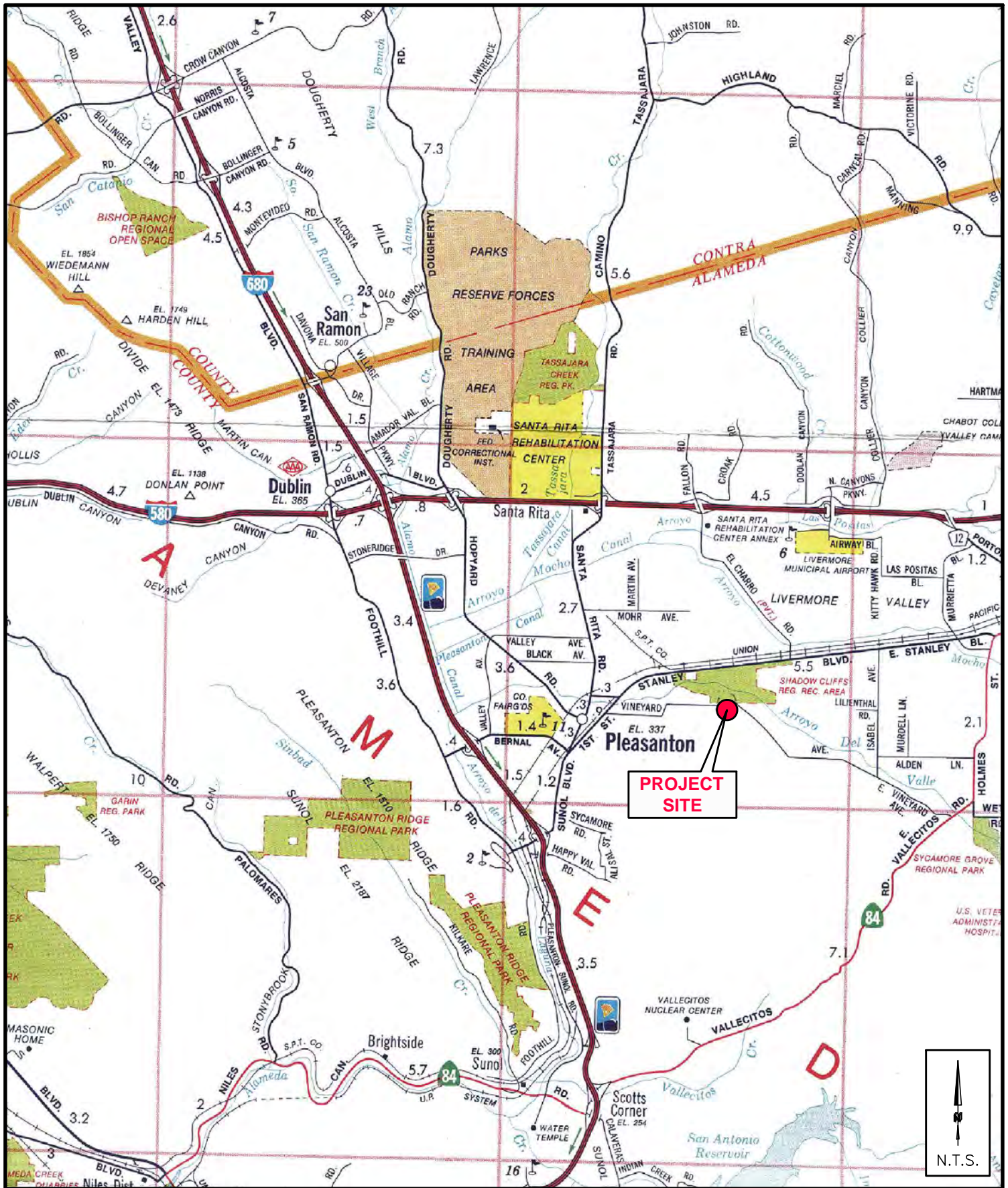
Mike Delmanowski, C.E.G., C.Hg.
Senior Hydrogeologist



cc: Mr. Eric Lauritsen, Pleasanton Garbage Service, Inc. (via email)

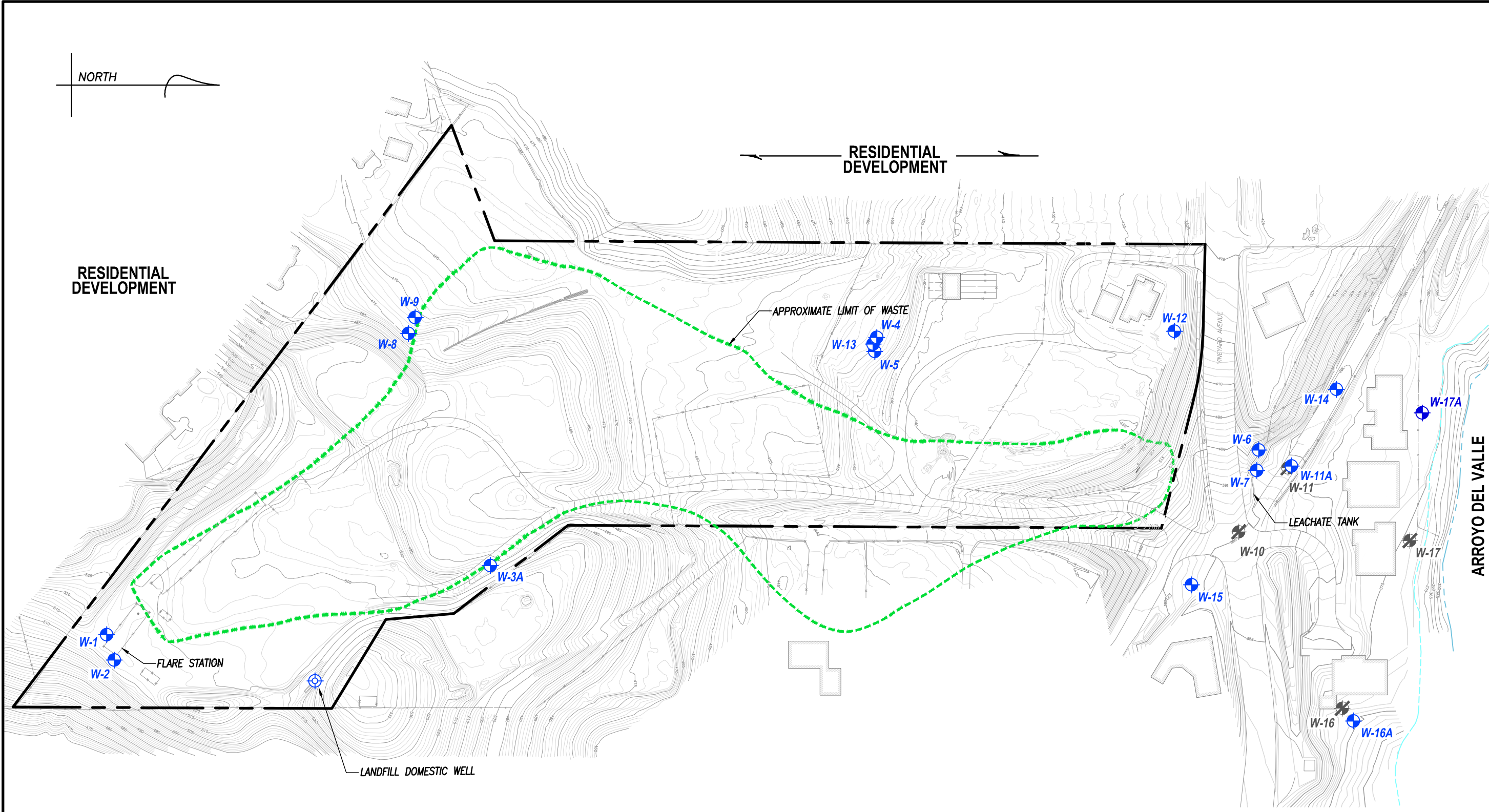
Enclosures: Appendix A - Figures
Appendix B - Field Sampling Data Forms
Appendix C - Tabulated Summary of Analytical Results
Appendix D - Certified Analytical Report and Chain-of-Custody Record

APPENDIX A
FIGURES



LOCATION MAP
 OLD PLEASANTON LANDFILL
 ALAMEDA COUNTY, CALIFORNIA

FIGURE
1
 97-609



BOUNDARY NOTES:
1. BOUNDARY SHOWN IS APPROXIMATE ONLY.
THIS MAP IS NOT A RECORD OF SURVEY

TOPOGRAPHIC NOTE:

AERIAL PHOTOMAPPING SERVICES		THIS MAP CONFORMS TO NATIONAL MAP ACCURACY STANDARDS FOR THE SCALE AND C.I. NOTED
2929 LARKIN AVE. CLOVIS, CA. 93612 (559) 291-0147	DATE OF PHOTOGRAPHY: 1-09-02	
	MAP SCALE: 1"=40'	
	CONTOUR INTERVAL: 1'	

LEGEND

- W-16A GROUNDWATER MONITORING WELL
- W-16 ABANDONED GROUNDWATER MONITORING WELL

MONITORING NETWORK

OLD PLEASANTON LANDFILL
ALAMEDA COUNTY, CALIFORNIA

EBA
ENGINEERING
825 SONOMA AVENUE
SUITE C
SANTA ROSA, CA. 95404
TEL: (707) 544-0784

C:\97-609\Fig.2 - Monitoring Network - (Rev.1) .dwg, 5/10/2019 7:55:29 AM

APPENDIX B
FIELD SAMPLING DATA FORMS



DEL-TECH GEOTECHNICAL SUPPORT SERVICES, INC.

MONITORING WELL FIELD LOG 2019

SAMPLE LOCATION - **W-6** **DATE:** 8/20/2019

PROJECT NAME:	OLD PLEASANTON LANDFILL	ANALYSIS PERFORMED:	SEE CHAIN OF CUSTODY
ADDRESS:	2512 VINEYARD AVENUE	SAMPLE TIME:	12:15
CITY, STATE:	PLEASANTON, CA	SAMPLE CONTAINERS:	SEE CHAIN OF CUSTODY
SITE CONTACT:	MIKE DELMANOWSKI	PRESERVATIVES:	SEE CHAIN OF CUSTODY
CONSULTANT:	EBA ENGINEERING	LAB. ANALYSIS BY:	TESTAMERICA

PROJECT MANAGER:	MIKE DELMANOWSKI	SCREENED INTERVAL (ft.):	42	TO	47
SAMPLER:	DEL-TECH / ASHLEY PUTNAM	WELL CASING MATERIAL:	PVC		
SIGNED:	<i>Ashley Putnam</i>	WELL CASING DIAMETER:	4" / 0.6528	GAL/FT	
SAMPLE MEDIA:	GROUNDWATER	P.I.D. READING / ODOR:	N/A	NONE	
T.O.C. ELEVATION:	(feet 100th's) 402.58	COLOR:		CLEAR	
DEPTH TO WATER:	(feet 100th's) 31.87	CALC. PURGE VOLUME:		11.59	GALLONS
DEPTH OF WELL:	(feet 100th's) 49.63	TOTAL VOLUME PURGED:		12.00	GALLONS
STANDING WATER COLUMN:	17.76	DEPTH OF PUMP:		~ 45	FEET

FIELD PARAMETERS

TIME		ACTUAL VOLUME PURGED	D.T.W. (feet)	PUMPING RATE (GPM)	pH (units)	E. C. (uS/cm)	TEMP. (Celsius)	O.R.P. (Mvolts)	DISSOLVED OXYGEN (PPM)	TURBIDITY (N.T.U.)
11:42		0.00	33.12	~ 0.5	6.68	1093	20.4	131		21
11:49		3.00	36.60	"	6.67	1086	20.4	134		5
11:56		3.00	39.42	"	6.73	1086	20.6	136		4
12:03		3.00	42.42	"	6.74	1087	20.8	135		4
12:10		3.00	43.77	"	6.75	1090	20.9	138		5
12:15	SAMPLED									

PURGE METHOD:	DEDICATED HDPE TUBING & WATERRA INERTIAL PUMP.
SAMPLE METHOD:	DEDICATED HDPE TUBING & WATERRA INERTIAL PUMP.
D. T. W. AFTER PURGE:	D. T. W. AT SAMPLE TIME: 43.75'
WELL INTEGRITY:	CAP & SEAL ARE SECURE.
WELL LOCATION:	SEE SITE MAP.
REMARKS:	ADDITIONAL PFAS SAMPLES AND PRECAUTIONS TAKEN DURING THIS EVENT. FRB SAMPLE TAKEN HERE AT 11:53. DEDICATED WATERRA TUBING INSTALLED.
WEATHER:	OVERCAST / COOL WIND:
QUALITY CONTROL:	WATER LEVEL METER WAS CLEANED AS NECESSARY. NEW NITRILE GLOVES. WELL EQUIPPED WITH DEDICATED PURGE TUBING.
CONTAINMENT:	PURGE WATER TO LEACHATE UST.
INSTRUMENTATION:	MYRON 6P MULTI METER HERON D.T.W. METER OAKTON TURBIDITY METER



DEL-TECH GEOTECHNICAL SUPPORT SERVICES, INC.

MONITORING WELL FIELD LOG 2019

SAMPLE LOCATION -	W-9	DATE:	8/20/2019
PROJECT NAME:	OLD PLEASANTON LANDFILL	ANALYSIS PERFORMED:	SEE CHAIN OF CUSTODY
ADDRESS:	2512 VINEYARD AVENUE	SAMPLE TIME:	10:18
CITY, STATE:	PLEASANTON, CA	SAMPLE CONTAINERS:	SEE CHAIN OF CUSTODY
SITE CONTACT:	MIKE DELMANOWSKI	PRESERVATIVES:	SEE CHAIN OF CUSTODY
CONSULTANT:	EBA ENGINEERING	LAB. ANALYSIS BY:	TESTAMERICA

PROJECT MANAGER:	MIKE DELMANOWSKI	SCREENED INTERVAL (ft.):	67 TO 87
SAMPLER:	DEL-TECH / ASHLEY PUTNAM	WELL CASING MATERIAL:	PVC
SIGNED:	<i>Ashley Putnam</i>	WELL CASING DIAMETER:	4" / 0.6528 GAL/FT
SAMPLE MEDIA:	GROUNDWATER	P.I.D. READING / ODOR:	N/A NONE
T.O.C. ELEVATION:	(feet 100th's) 475.18 MSL	COLOR:	LIGHT BROWN
DEPTH TO WATER:	(feet 100th's) 31.60 FEET	CALC. PURGE VOLUME:	37.41 GALLONS
DEPTH OF WELL:	(feet 100th's) 88.90 FEET	TOTAL VOLUME PURGED:	52.00 GALLONS
STANDING WATER COLUMN:	57.30 FEET	DEPTH OF PUMP:	~ 85 FEET

FIELD PARAMETERS

TIME		ACTUAL VOLUME PURGED	D.T.W. (feet)	PUMPING RATE (GPM)	pH (units)	E. C. (uS/cm)	TEMP. (Celsius)	O.R.P. (Mvolts)	DISSOLVED OXYGEN (PPM)	TURBIDITY (N.T.U.)
9:24		0.00	32.43	1.00	8.26	534	19.8	120		27
9:37		13.00	33.52	"	8.07	530	19.7	72		32
9:50		13.00	33.76	"	8.06	526	19.8	54		20
10:03		13.00	33.93	"	8.00	522	20.0	43		13
10:16		13.00	34.00	"	8.03	521	20.3	40		10
10:18	SAMPLED									

PURGE METHOD:	DEDICATED HDPE TUBING & WATERRA INERTIAL PUMP.
SAMPLE METHOD:	DEDICATED HDPE TUBING & WATERRA INERTIAL PUMP.
D. T. W. AFTER PURGE:	D. T. W. AT SAMPLE TIME: 34.03'
WELL INTEGRITY:	CAP & SEAL ARE SECURE.
WELL LOCATION:	SEE SITE MAP.
REMARKS:	ADDITIONAL PFAS SAMPLES AND PRECAUTIONS TAKEN DURING THIS EVENT. DEDICATED WATERRA TUBING INSTALLED.
WEATHER:	OVERCAST / COOL
WIND:	
QUALITY CONTROL:	WATER LEVEL METER WAS CLEANED AS NECESSARY. NEW NITRILE GLOVES. WELL EQUIPPED WITH DEDICATED PURGE TUBING.
CONTAINMENT:	55 GALLON DRUMS
INSTRUMENTATION:	MYRON 6P MULTI METER HERON D.T.W. METER OAKTON TURBIDITY METER



DEL-TECH GEOTECHNICAL SUPPORT SERVICES, INC.

MONITORING WELL FIELD LOG 2019

SAMPLE LOCATION - **W-14** **DATE:** 8/20/2019

PROJECT NAME:	OLD PLEASANTON LANDFILL	ANALYSIS PERFORMED:	SEE CHAIN OF CUSTODY
ADDRESS:	2512 VINEYARD AVENUE	SAMPLE TIME:	11:20
CITY, STATE:	PLEASANTON, CA	SAMPLE CONTAINERS:	SEE CHAIN OF CUSTODY
SITE CONTACT:	MIKE DELMANOWSKI	PRESERVATIVES:	SEE CHAIN OF CUSTODY
CONSULTANT:	EBA ENGINEERING	LAB. ANALYSIS BY:	TESTAMERICA

PROJECT MANAGER:	MIKE DELMANOWSKI	SCREENED INTERVAL (ft.):	30	TO	45
SAMPLER:	DEL-TECH / ASHLEY PUTNAM	WELL CASING MATERIAL:	PVC		
SIGNED:	<i>Ashley Putnam</i>	WELL CASING DIAMETER:	2" / 0.1632	GAL/FT	
SAMPLE MEDIA:	GROUNDWATER	P.I.D. READING / ODOR:	N/A	NONE	
T.O.C. ELEVATION:	(feet 100th's) 387.27	MSL		COLOR: BROWN	
DEPTH TO WATER:	(feet 100th's) 22.86	FEET		CALC. PURGE VOLUME: 3.60 GALLONS	
DEPTH OF WELL:	(feet 100th's) 44.90	FEET		TOTAL VOLUME PURGED: 12.00 GALLONS	
STANDING WATER COLUMN:	22.04	FEET		DEPTH OF PUMP: ~ 41 FEET	

FIELD PARAMETERS

TIME		ACTUAL VOLUME PURGED	D.T.W. (feet)	PUMPING RATE (GPM)	pH (units)	E. C. (uS/cm)	TEMP. (Celsius)	O.R.P. (Mvolts)	DISSOLVED OXYGEN (PPM)	TURBIDITY (N.T.U.)
10:54		0.0	24.14	0.50	6.80	1236	19.5	201		322
11:00		3.0	25.18	"	6.44	1237	19.0	187		155
11:06		3.0	25.62	"	6.36	1232	19.1	168		98
11:12		3.0	25.98	"	6.35	1227	18.9	158		73
11:18		3.0	26.01	"	6.35	1222	18.8	158		67
11:20	SAMPLED									

PURGE METHOD:	DEDICATED HDPE TUBING & WATERRA INERTIAL PUMP.
SAMPLE METHOD:	DEDICATED HDPE TUBING & WATERRA INERTIAL PUMP.
D. T. W. AFTER PURGE:	D. T. W. AT SAMPLE TIME: 26.10'
WELL INTEGRITY:	CAP & SEAL ARE SECURE.
WELL LOCATION:	SEE SITE MAP.
REMARKS:	ADDITIONAL PFAS SAMPLES AND PRECAUTIONS TAKEN DURING THIS EVENT. DEDICATED WATERRA TUBING INSTALLED.
WEATHER:	OVERCAST / COOL WIND:
QUALITY CONTROL:	WATER LEVEL METER WAS CLEANED AS NECESSARY. NEW NITRILE GLOVES. WELL EQUIPPED WITH DEDICATED PURGE TUBING.
CONTAINMENT:	PURGE WATER TO LEACHATE UST.
INSTRUMENTATION:	MYRON 6P MULTI METER HERON D.T.W. METER OAKTON TURBIDITY METER



DEL-TECH GEOTECHNICAL SUPPORT SERVICES, INC.

(209) 847-8757 (OFFICE) * don@deltech1.com (Email)



INSTRUMENT CALIBRATION LOG 2019

PROJECT NAME: OLD PLEASANTON LANDFILL	PROJECT MANAGER: MIKE DELMANOWSKI
ADDRESS: 2512 VINEYARD AVENUE	SAMPLER: DEL TECH / ANTONIO MORALES & ASHLEY PUTNAM
CITY, STATE: PLEASANTON, CA	SIGNED: <i>Antonio H. Morales</i> <i>Ashley Putnam</i>
SITE CONTACT: MIKE DELMANOWSKI	SAMPLE MEDIA: GROUNDWATER / SURFACE WATER
CONSULTANT: EBA ENGINEERING	MONTH : AUGUST

CALIBRATION RECORDINGS

CALIBRATION STANDARDS *

DATE TIME	INSTRUMENT METER CALIBRATION	SERIAL #	Ph 4	Ph 7	Ph 10	COND. 1413 MHOS	TURBIDITY 20	TURBIDITY 100	INSTRUMENT CONDITION
			READING	READING	READING	(Celsius)	(N.T.U.)	(N.T.U.)	
	08/19/19	6250921					2228752		GOOD
7:00	PRE-CALIBRATION:		4.11	7.01	10.03	1420	20	100	
	CALIBRATION		4.00	7.00	10.00	1413	20	100	
	CAL. SUCCESSFUL (Y/N)		YES	YES	YES	YES	YES	YES	
	SATIFIES PROTOCOL ?		YES	YES	YES	YES	YES	YES	
	CALBRATED BY:	<i>Antonio H. Morales</i>							
	08/20/19	6250921					2228752		GOOD
7:00	PRE-CALIBRATION:		4.25	7.00	10.10	1418	20	100	
	CALIBRATION		4.00	7.00	10.00	1413	20	100	
	CAL. SUCCESSFUL (Y/N)		YES	YES	YES	YES	YES	YES	
	SATIFIES PROTOCOL ?		YES	YES	YES	YES	YES	YES	
	CALBRATED BY:	<i>Antonio H. Morales</i>							
	08/19/19	6250922					2781820		GOOD
11:11	PRE-CALIBRATION:		3.95	6.98	9.98	1413	20	100	
	CALIBRATION		4.00	7.00	10.00	1413	20	100	
	CAL. SUCCESSFUL (Y/N)		YES	YES	YES	YES	YES	YES	
	SATIFIES PROTOCOL ?		YES	YES	YES	YES	YES	YES	
	CALBRATED BY:	<i>Ashley Putnam</i>							
	08/20/19	6250922					2781820		GOOD
7:22	PRE-CALIBRATION:		4.00	7.04	9.98	1411	20	100	
	CALIBRATION		4.00	7.00	10.00	1413	20	100	
	CAL. SUCCESSFUL (Y/N)		YES	YES	YES	YES	YES	YES	
	SATIFIES PROTOCOL ?		YES	YES	YES	YES	YES	YES	
	CALBRATED BY:	<i>Ashley Putnam</i>							
	PRE-CALIBRATION:								
	CALIBRATION								
	CAL. SUCCESSFUL (Y/N)								
	SATIFIES PROTOCOL ?								
	CALBRATED BY:								

* NOTE: UPON COMPLETING THE INITIAL READINGS OF THE INSTRUMENT , WE WILL ALWAYS ADJUST TO THE INSTRUMENT TO THE CALIBRATION STANDARD SOLUTION THAT IS BEING USED AT THAT TIME AND AT THE CURRENT AMBIENT TEMPERATURE.

APPENDIX C

**TABULATED SUMMARY OF
ANALYTICAL RESULTS**

SUMMARY OF ANALYTICAL RESULTS
METHOD: EPA 537(MOD)
PFAS for QSM 5.1, TABLE B-15
OLD PLEASANTON LANDFILL
AUGUST 20, 2019

<i>Analyte</i>	<i>Units</i>	<i>W-6</i>	<i>W-9</i>	<i>W-14</i>	<i>FRB</i>
Perfluorobutanoic Acid (PFBA)	ng/L	23	<1.7	16	<1.7
Perfluoropentanoic Acid (PFPeA)	ng/L	3.7	<1.7	4.1	<1.7
Perfluorohexanoic Acid (PFHxA)	ng/L	3.4	<1.7	4.8	<1.7
Perfluoroheptanoic Acid (PFHpA)	ng/L	4.8	<1.7	4.6	<1.7
Perfluorooctanoic Acid (PFOA)	ng/L	37	<1.7	29	<1.7
Perfluorononanoic Acid (PFNA)	ng/L	<1.8	<1.7	<1.7	<1.7
Perfluorodecanoic Acid (PFDA)	ng/L	<1.8	<1.7	<1.7	<1.7
Perfluoroundecanoic Acid (PFUnA)	ng/L	<1.8	<1.7	<1.7	<1.7
Perfluorododecanoic Acid (PFDoA)	ng/L	<1.8	<1.7	<1.7	<1.7
Perfluorotridecanoic Acid (PFTriA)	ng/L	<1.8	<1.7	<1.7	<1.7
Perfluorotetradecanoic Acid (PFTeA)	ng/L	<1.8	<1.7	<1.7	<1.7
Perfluorobutanesulfonic Acid (PFBS)	ng/L	8.3	<1.7	9.2	<1.7
Perfluoropentanesulfonic Acid (PFPeS)	ng/L	3.3	<1.7	3.7	<1.7
Perfluorohexanesulfonic Acid (PFHxS)	ng/L	5.8	<1.7	6.2	<1.7
Perfluoroheptanesulfonic Acid (PFHpS)	ng/L	<1.8	<1.7	<1.7	<1.7
Perfluorooctanesulfonic Acid (PFOS)	ng/L	12	<1.7	7.4	<1.7
Perfluorononanesulfonic Acid (PFNS)	ng/L	<1.8	<1.7	<1.7	<1.7
Perfluorodecanesulfonic Acid (PFDS)	ng/L	<1.8	<1.7	<1.7	<1.7
Perfluorooctanesulfonamide (FOSA)	ng/L	<1.8	<1.7	<1.7	<1.7
N-methylperfluorooctanesulfonamidoacetic Acid (NMeFOSAA)	ng/L	<18	<17	<17	<17
N-ethylperfluorooctanesulfonamidoacetic Acid (NEtFOSAA)	ng/L	<18	<17	<17	<17
4:2 FTS	ng/L	<18	<17	<17	<17
6:2 FTS	ng/L	<18	<17	<17	<17
8:2 FTS	ng/L	<18	<17	<17	<17

PFAS: Per- and Polyfluoroalkyl Substances

ng/L: Nanograms per Liter

FRB: Field Reagent Blank

APPENDIX D

**CERTIFIED ANALYTICAL REPORT
AND
CHAIN-OF-CUSTODY RECORD**

ANALYTICAL REPORT

Eurofins TestAmerica, Sacramento
880 Riverside Parkway
West Sacramento, CA 95605
Tel: (916)373-5600

Laboratory Job ID: 320-53481-1
Laboratory SDG: 2512 VINEYARD AVENUE, PLEASANTON, CA.
Client Project/Site: OLD PLEASANTON LANDFILL

For:
EBA Engineering
825 Sonoma Avenue
Santa Rosa, California 95404

Attn: Mike Delmanowski



Authorized for release by:
9/19/2019 3:35:07 PM
David Alltucker, Project Manager I
(916)374-4383
david.alltucker@testamericainc.com

Designee for
Cesar Cortes, Project Manager I
(916)374-4316
cesar.cortes@testamericainc.com

LINKS

Review your project
results through
TotalAccess

Have a Question?



Visit us at:
www.testamericainc.com

The test results in this report meet all 2003 NELAC and 2009 TNI requirements for accredited parameters, exceptions are noted in this report. This report may not be reproduced except in full, and with written approval from the laboratory. For questions please contact the Project Manager at the e-mail address or telephone number listed on this page.

This report has been electronically signed and authorized by the signatory. Electronic signature is intended to be the legally binding equivalent of a traditionally handwritten signature.

Results relate only to the items tested and the sample(s) as received by the laboratory.



Table of Contents

Cover Page	1
Table of Contents	2
Definitions/Glossary	3
Case Narrative	4
Detection Summary	5
Client Sample Results	6
Isotope Dilution Summary	10
QC Sample Results	11
QC Association Summary	15
Lab Chronicle	16
Certification Summary	17
Method Summary	18
Sample Summary	19
Chain of Custody	20
Receipt Checklists	21

Definitions/Glossary

Client: EBA Engineering
Project/Site: OLD PLEASANTON LANDFILL

Job ID: 320-53481-1
SDG: 2512 VINEYARD AVENUE, PLEASANTON, CA.

Glossary

Abbreviation	These commonly used abbreviations may or may not be present in this report.
α	Listed under the "D" column to designate that the result is reported on a dry weight basis
%R	Percent Recovery
CFL	Contains Free Liquid
CNF	Contains No Free Liquid
DER	Duplicate Error Ratio (normalized absolute difference)
Dil Fac	Dilution Factor
DL	Detection Limit (DoD/DOE)
DL, RA, RE, IN	Indicates a Dilution, Re-analysis, Re-extraction, or additional Initial metals/anion analysis of the sample
DLC	Decision Level Concentration (Radiochemistry)
EDL	Estimated Detection Limit (Dioxin)
LOD	Limit of Detection (DoD/DOE)
LOQ	Limit of Quantitation (DoD/DOE)
MDA	Minimum Detectable Activity (Radiochemistry)
MDC	Minimum Detectable Concentration (Radiochemistry)
MDL	Method Detection Limit
ML	Minimum Level (Dioxin)
NC	Not Calculated
ND	Not Detected at the reporting limit (or MDL or EDL if shown)
PQL	Practical Quantitation Limit
QC	Quality Control
RER	Relative Error Ratio (Radiochemistry)
RL	Reporting Limit or Requested Limit (Radiochemistry)
RPD	Relative Percent Difference, a measure of the relative difference between two points
TEF	Toxicity Equivalent Factor (Dioxin)
TEQ	Toxicity Equivalent Quotient (Dioxin)

Case Narrative

Client: EBA Engineering
Project/Site: OLD PLEASANTON LANDFILL

Job ID: 320-53481-1
SDG: 2512 VINEYARD AVENUE, PLEASANTON, CA.

Job ID: 320-53481-1

Laboratory: Eurofins TestAmerica, Sacramento

Narrative

Job Narrative 320-53481-1

Receipt

The samples were received on 8/20/2019 6:15 PM; the samples arrived in good condition, properly preserved and, where required, on ice. The temperature of the cooler at receipt was 11.4° C.

Receipt Exceptions

The following samples were received at the laboratory outside the required temperature criteria: W-9 (320-53481-1), W-14 (320-53481-2), W-6 (320-53481-3) and FRB (320-53481-4). The sample is considered acceptable since it was collected and submitted to the laboratory on the same day and there is evidence that the chilling process has begun.

The container label for the following samples did not match the information listed on the Chain-of-Custody (COC): W-9 (320-53481-1), W-14 (320-53481-2), W-6 (320-53481-3) and FRB (320-53481-4). The container labels list no time, while the COC lists does have a time.

LCMS

Method(s) EPA 537 (Mod), EPA 537(Mod): The first level standard from the initial calibration curve is used to evaluate the tune criteria. The instrument mass windows are set at +/- 0.5amu; therefore, detection of the analyte serves as verification that the assigned mass is within +/- 0.5amu of the true value, which meets the DoD/DOE QSM tune criterion.

Method(s) EPA 537 (Mod), EPA 537(Mod): Due to a shortage in the marketplace for 13C3-PFBS, the target analyte PFBS could not be quantitated against 13C3-PFBS (its labeled variant) as listed in the SOP. PFBS was quantitated versus 18O2-PFHxS instead.

Method(s) EPA 537(Mod): The "1" qualifier means the transition mass ratio for the indicated analyte(s) was outside of the established ratio limits. The qualitative identification of the analyte(s) has/have some degree of uncertainty. However, analyst judgement was used to positively identify the analyte(s). W-14 (320-53481-2)

Method(s) EPA 537 (Mod), EPA 537(Mod): Isotope Dilution Analyte (IDA) recovery is above the method recommended limit for the following Initial Calibration Blank (ICB): (ICB 320-321360/10). The target analyte 6:2FTS is non-detect in the ICB. Quantitation by isotope dilution generally precludes any adverse effect on data quality due to elevated IDA recoveries. IDA method acceptance criteria is not specified in the SOP for the ICB. M2-6:2FTS in the bracketing Continuing Calibration Standards (CCV) and samples was within control limits. There is no impact on the data, therefore, the data were reported.

No additional analytical or quality issues were noted, other than those described above or in the Definitions/Glossary page.

Organic Prep

Method(s) 3535: Insufficient sample volume was available to perform a matrix spike/matrix spike duplicate (MS/MSD) associated with preparation batch 320-317425.

Method(s) 3535: the following sample is light brown prior to extraction W-14 (320-53481-2)

Method(s) 3535: During the solid phase extraction process, the following sample has non-settleable particulates which clogged the solid phase extraction column: W-14 (320-53481-2).

Method(s) 3535: Insufficient sample volume was available to perform a matrix spike/matrix spike duplicate (MS/MSD) associated with 320-320464

No additional analytical or quality issues were noted, other than those described above or in the Definitions/Glossary page.

Detection Summary

Client: EBA Engineering
Project/Site: OLD PLEASANTON LANDFILL

Job ID: 320-53481-1
SDG: 2512 VINEYARD AVENUE, PLEASANTON, CA.

Client Sample ID: W-9

Lab Sample ID: 320-53481-1

No Detections.

Client Sample ID: W-14

Lab Sample ID: 320-53481-2

Analyte	Result	Qualifier	RL	MDL	Unit	Dil Fac	D	Method	Prep Type
Perfluorobutanoic acid (PFBA)	16		1.7	0.30	ng/L	1		EPA 537(Mod)	Total/NA
Perfluoropentanoic acid (PFPeA)	4.1		1.7	0.42	ng/L	1		EPA 537(Mod)	Total/NA
Perfluorohexanoic acid (PFHxA)	4.8		1.7	0.49	ng/L	1		EPA 537(Mod)	Total/NA
Perfluoroheptanoic acid (PFHpA)	4.6		1.7	0.21	ng/L	1		EPA 537(Mod)	Total/NA
Perfluorooctanoic acid (PFOA)	29		1.7	0.72	ng/L	1		EPA 537(Mod)	Total/NA
Perfluorobutanesulfonic acid (PFBS)	9.2		1.7	0.17	ng/L	1		EPA 537(Mod)	Total/NA
Perfluoropentanesulfonic acid (PFPeS)	3.7		1.7	0.25	ng/L	1		EPA 537(Mod)	Total/NA
Perfluorohexanesulfonic acid (PFHxS)	6.2		1.7	0.14	ng/L	1		EPA 537(Mod)	Total/NA
Perfluorooctanesulfonic acid (PFOS)	7.4		1.7	0.46	ng/L	1		EPA 537(Mod)	Total/NA

Client Sample ID: W-6

Lab Sample ID: 320-53481-3

Analyte	Result	Qualifier	RL	MDL	Unit	Dil Fac	D	Method	Prep Type
Perfluorobutanoic acid (PFBA)	23		1.8	0.31	ng/L	1		EPA 537(Mod)	Total/NA
Perfluoropentanoic acid (PFPeA)	3.7		1.8	0.43	ng/L	1		EPA 537(Mod)	Total/NA
Perfluorohexanoic acid (PFHxA)	3.4		1.8	0.51	ng/L	1		EPA 537(Mod)	Total/NA
Perfluoroheptanoic acid (PFHpA)	4.8		1.8	0.22	ng/L	1		EPA 537(Mod)	Total/NA
Perfluorooctanoic acid (PFOA)	37		1.8	0.75	ng/L	1		EPA 537(Mod)	Total/NA
Perfluorobutanesulfonic acid (PFBS)	8.3		1.8	0.18	ng/L	1		EPA 537(Mod)	Total/NA
Perfluoropentanesulfonic acid (PFPeS)	3.3		1.8	0.26	ng/L	1		EPA 537(Mod)	Total/NA
Perfluorohexanesulfonic acid (PFHxS)	5.8		1.8	0.15	ng/L	1		EPA 537(Mod)	Total/NA
Perfluorooctanesulfonic acid (PFOS)	12		1.8	0.48	ng/L	1		EPA 537(Mod)	Total/NA

Client Sample ID: FRB

Lab Sample ID: 320-53481-4

No Detections.

This Detection Summary does not include radiochemical test results.

Eurofins TestAmerica, Sacramento

Client Sample Results

Client: EBA Engineering
Project/Site: OLD PLEASANTON LANDFILL

Job ID: 320-53481-1
SDG: 2512 VINEYARD AVENUE, PLEASANTON, CA.

Client Sample ID: W-9

Lab Sample ID: 320-53481-1

Date Collected: 08/20/19 10:18

Matrix: Water

Date Received: 08/20/19 18:15

Method: EPA 537(Mod) - PFAS for QSM 5.1, Table B-15

Analyte	Result	Qualifier	RL	MDL	Unit	D	Prepared	Analyzed	Dil Fac
Perfluorobutanoic acid (PFBA)	ND		1.7	0.30	ng/L		09/03/19 19:53	09/06/19 18:07	1
Perfluoropentanoic acid (PFPeA)	ND		1.7	0.42	ng/L		09/03/19 19:53	09/06/19 18:07	1
Perfluorohexanoic acid (PFHxA)	ND		1.7	0.50	ng/L		09/03/19 19:53	09/06/19 18:07	1
Perfluoroheptanoic acid (PFHpA)	ND		1.7	0.21	ng/L		09/03/19 19:53	09/06/19 18:07	1
Perfluorooctanoic acid (PFOA)	ND		1.7	0.73	ng/L		09/03/19 19:53	09/06/19 18:07	1
Perfluorononanoic acid (PFNA)	ND		1.7	0.23	ng/L		09/03/19 19:53	09/06/19 18:07	1
Perfluorodecanoic acid (PFDA)	ND		1.7	0.27	ng/L		09/03/19 19:53	09/06/19 18:07	1
Perfluoroundecanoic acid (PFUnA)	ND		1.7	0.94	ng/L		09/03/19 19:53	09/06/19 18:07	1
Perfluorododecanoic acid (PFDoA)	ND		1.7	0.47	ng/L		09/03/19 19:53	09/06/19 18:07	1
Perfluorotridecanoic acid (PFTriA)	ND		1.7	1.1	ng/L		09/03/19 19:53	09/06/19 18:07	1
Perfluorotetradecanoic acid (PFTeA)	ND		1.7	0.25	ng/L		09/03/19 19:53	09/06/19 18:07	1
Perfluorobutanesulfonic acid (PFBS)	ND		1.7	0.17	ng/L		09/03/19 19:53	09/06/19 18:07	1
Perfluoropentanesulfonic acid (PFPeS)	ND		1.7	0.26	ng/L		09/03/19 19:53	09/06/19 18:07	1
Perfluorohexanesulfonic acid (PFHxS)	ND		1.7	0.15	ng/L		09/03/19 19:53	09/06/19 18:07	1
Perfluoroheptanesulfonic Acid (PFHpS)	ND		1.7	0.16	ng/L		09/03/19 19:53	09/06/19 18:07	1
Perfluorooctanesulfonic acid (PFOS)	ND		1.7	0.46	ng/L		09/03/19 19:53	09/06/19 18:07	1
Perfluorononanesulfonic acid (PFNS)	ND		1.7	0.14	ng/L		09/03/19 19:53	09/06/19 18:07	1
Perfluorodecanesulfonic acid (PFDS)	ND		1.7	0.27	ng/L		09/03/19 19:53	09/06/19 18:07	1
Perfluorooctanesulfonamide (FOSA)	ND		1.7	0.30	ng/L		09/03/19 19:53	09/06/19 18:07	1
N-methylperfluorooctanesulfonamidoacetic acid (NMeFOSAA)	ND		17	2.7	ng/L		09/03/19 19:53	09/06/19 18:07	1
N-ethylperfluorooctanesulfonamidoacetic acid (NEtFOSAA)	ND		17	1.6	ng/L		09/03/19 19:53	09/06/19 18:07	1
4:2 FTS	ND		17	4.4	ng/L		09/03/19 19:53	09/06/19 18:07	1
6:2 FTS	ND		17	1.7	ng/L		09/03/19 19:53	09/06/19 18:07	1
8:2 FTS	ND		17	1.7	ng/L		09/03/19 19:53	09/06/19 18:07	1

Isotope Dilution	%Recovery	Qualifier	Limits	Prepared	Analyzed	Dil Fac
13C4 PFBA	97		50 - 150	09/03/19 19:53	09/06/19 18:07	1
13C5 PFPeA	94		50 - 150	09/03/19 19:53	09/06/19 18:07	1
13C2 PFHxA	97		50 - 150	09/03/19 19:53	09/06/19 18:07	1
13C4 PFHpA	99		50 - 150	09/03/19 19:53	09/06/19 18:07	1
13C4 PFOA	96		50 - 150	09/03/19 19:53	09/06/19 18:07	1
13C5 PFNA	96		50 - 150	09/03/19 19:53	09/06/19 18:07	1
13C2 PFDA	98		50 - 150	09/03/19 19:53	09/06/19 18:07	1
13C2 PFUnA	90		50 - 150	09/03/19 19:53	09/06/19 18:07	1
13C2 PFDoA	83		50 - 150	09/03/19 19:53	09/06/19 18:07	1
13C2 PFTeDA	84		50 - 150	09/03/19 19:53	09/06/19 18:07	1
18O2 PFHxS	106		50 - 150	09/03/19 19:53	09/06/19 18:07	1
13C4 PFOS	99		50 - 150	09/03/19 19:53	09/06/19 18:07	1
13C8 FOSA	95		50 - 150	09/03/19 19:53	09/06/19 18:07	1
d3-NMeFOSAA	87		50 - 150	09/03/19 19:53	09/06/19 18:07	1
d5-NEtFOSAA	83		50 - 150	09/03/19 19:53	09/06/19 18:07	1
M2-6:2 FTS	108		50 - 150	09/03/19 19:53	09/06/19 18:07	1
M2-8:2 FTS	101		50 - 150	09/03/19 19:53	09/06/19 18:07	1
M2-4:2 FTS	99		50 - 150	09/03/19 19:53	09/06/19 18:07	1

Eurofins TestAmerica, Sacramento

Client Sample Results

Client: EBA Engineering
Project/Site: OLD PLEASANTON LANDFILL

Job ID: 320-53481-1
SDG: 2512 VINEYARD AVENUE, PLEASANTON, CA.

Client Sample ID: W-14
Date Collected: 08/20/19 11:20
Date Received: 08/20/19 18:15

Lab Sample ID: 320-53481-2
Matrix: Water

Method: EPA 537(Mod) - PFAS for QSM 5.1, Table B-15

Analyte	Result	Qualifier	RL	MDL	Unit	D	Prepared	Analyzed	Dil Fac
Perfluorobutanoic acid (PFBA)	16		1.7	0.30	ng/L		09/03/19 19:54	09/06/19 18:17	1
Perfluoropentanoic acid (PFPeA)	4.1		1.7	0.42	ng/L		09/03/19 19:54	09/06/19 18:17	1
Perfluorohexanoic acid (PFHxA)	4.8		1.7	0.49	ng/L		09/03/19 19:54	09/06/19 18:17	1
Perfluoroheptanoic acid (PFHpA)	4.6		1.7	0.21	ng/L		09/03/19 19:54	09/06/19 18:17	1
Perfluorooctanoic acid (PFOA)	29		1.7	0.72	ng/L		09/03/19 19:54	09/06/19 18:17	1
Perfluorononanoic acid (PFNA)	ND		1.7	0.23	ng/L		09/03/19 19:54	09/06/19 18:17	1
Perfluorodecanoic acid (PFDA)	ND		1.7	0.26	ng/L		09/03/19 19:54	09/06/19 18:17	1
Perfluoroundecanoic acid (PFUnA)	ND		1.7	0.93	ng/L		09/03/19 19:54	09/06/19 18:17	1
Perfluorododecanoic acid (PFDoA)	ND		1.7	0.47	ng/L		09/03/19 19:54	09/06/19 18:17	1
Perfluorotridecanoic acid (PFTriA)	ND		1.7	1.1	ng/L		09/03/19 19:54	09/06/19 18:17	1
Perfluorotetradecanoic acid (PFTeA)	ND		1.7	0.25	ng/L		09/03/19 19:54	09/06/19 18:17	1
Perfluorobutanesulfonic acid (PFBS)	9.2		1.7	0.17	ng/L		09/03/19 19:54	09/06/19 18:17	1
Perfluoropentanesulfonic acid (PFPeS)	3.7		1.7	0.25	ng/L		09/03/19 19:54	09/06/19 18:17	1
Perfluorohexanesulfonic acid (PFHxS)	6.2		1.7	0.14	ng/L		09/03/19 19:54	09/06/19 18:17	1
Perfluoroheptanesulfonic Acid (PFHpS)	ND		1.7	0.16	ng/L		09/03/19 19:54	09/06/19 18:17	1
Perfluorooctanesulfonic acid (PFOS)	7.4		1.7	0.46	ng/L		09/03/19 19:54	09/06/19 18:17	1
Perfluorononanesulfonic acid (PFNS)	ND		1.7	0.14	ng/L		09/03/19 19:54	09/06/19 18:17	1
Perfluorodecanesulfonic acid (PFDS)	ND		1.7	0.27	ng/L		09/03/19 19:54	09/06/19 18:17	1
Perfluorooctanesulfonamide (FOSA)	ND		1.7	0.30	ng/L		09/03/19 19:54	09/06/19 18:17	1
N-methylperfluorooctanesulfonamidoacetic acid (NMeFOSAA)	ND		17	2.6	ng/L		09/03/19 19:54	09/06/19 18:17	1
N-ethylperfluorooctanesulfonamidoacetic acid (NEtFOSAA)	ND		17	1.6	ng/L		09/03/19 19:54	09/06/19 18:17	1
4:2 FTS	ND		17	4.4	ng/L		09/03/19 19:54	09/06/19 18:17	1
6:2 FTS	ND		17	1.7	ng/L		09/03/19 19:54	09/06/19 18:17	1
8:2 FTS	ND		17	1.7	ng/L		09/03/19 19:54	09/06/19 18:17	1

Isotope Dilution	%Recovery	Qualifier	Limits	Prepared	Analyzed	Dil Fac
13C4 PFBA	77		50 - 150	09/03/19 19:54	09/06/19 18:17	1
13C5 PFPeA	90		50 - 150	09/03/19 19:54	09/06/19 18:17	1
13C2 PFHxA	94		50 - 150	09/03/19 19:54	09/06/19 18:17	1
13C4 PFHpA	97		50 - 150	09/03/19 19:54	09/06/19 18:17	1
13C4 PFOA	90		50 - 150	09/03/19 19:54	09/06/19 18:17	1
13C5 PFNA	92		50 - 150	09/03/19 19:54	09/06/19 18:17	1
13C2 PFDA	91		50 - 150	09/03/19 19:54	09/06/19 18:17	1
13C2 PFUnA	77		50 - 150	09/03/19 19:54	09/06/19 18:17	1
13C2 PFDoA	71		50 - 150	09/03/19 19:54	09/06/19 18:17	1
13C2 PFTeDA	66		50 - 150	09/03/19 19:54	09/06/19 18:17	1
18O2 PFHxS	101		50 - 150	09/03/19 19:54	09/06/19 18:17	1
13C4 PFOS	88		50 - 150	09/03/19 19:54	09/06/19 18:17	1
13C8 FOSA	85		50 - 150	09/03/19 19:54	09/06/19 18:17	1
d3-NMeFOSAA	79		50 - 150	09/03/19 19:54	09/06/19 18:17	1
d5-NEtFOSAA	74		50 - 150	09/03/19 19:54	09/06/19 18:17	1
M2-6:2 FTS	99		50 - 150	09/03/19 19:54	09/06/19 18:17	1
M2-8:2 FTS	92		50 - 150	09/03/19 19:54	09/06/19 18:17	1
M2-4:2 FTS	110		50 - 150	09/03/19 19:54	09/06/19 18:17	1

Eurofins TestAmerica, Sacramento

Client Sample Results

Client: EBA Engineering
Project/Site: OLD PLEASANTON LANDFILL

Job ID: 320-53481-1
SDG: 2512 VINEYARD AVENUE, PLEASANTON, CA.

Client Sample ID: W-6

Lab Sample ID: 320-53481-3

Date Collected: 08/20/19 12:15

Matrix: Water

Date Received: 08/20/19 18:15

Method: EPA 537(Mod) - PFAS for QSM 5.1, Table B-15

Analyte	Result	Qualifier	RL	MDL	Unit	D	Prepared	Analyzed	Dil Fac
Perfluorobutanoic acid (PFBA)	23		1.8	0.31	ng/L		09/03/19 19:54	09/06/19 18:26	1
Perfluoropentanoic acid (PFPeA)	3.7		1.8	0.43	ng/L		09/03/19 19:54	09/06/19 18:26	1
Perfluorohexanoic acid (PFHxA)	3.4		1.8	0.51	ng/L		09/03/19 19:54	09/06/19 18:26	1
Perfluoroheptanoic acid (PFHpA)	4.8		1.8	0.22	ng/L		09/03/19 19:54	09/06/19 18:26	1
Perfluorooctanoic acid (PFOA)	37		1.8	0.75	ng/L		09/03/19 19:54	09/06/19 18:26	1
Perfluorononanoic acid (PFNA)	ND		1.8	0.24	ng/L		09/03/19 19:54	09/06/19 18:26	1
Perfluorodecanoic acid (PFDA)	ND		1.8	0.27	ng/L		09/03/19 19:54	09/06/19 18:26	1
Perfluoroundecanoic acid (PFUnA)	ND		1.8	0.97	ng/L		09/03/19 19:54	09/06/19 18:26	1
Perfluorododecanoic acid (PFDoA)	ND		1.8	0.48	ng/L		09/03/19 19:54	09/06/19 18:26	1
Perfluorotridecanoic acid (PFTriA)	ND		1.8	1.1	ng/L		09/03/19 19:54	09/06/19 18:26	1
Perfluorotetradecanoic acid (PFTeA)	ND		1.8	0.26	ng/L		09/03/19 19:54	09/06/19 18:26	1
Perfluorobutanesulfonic acid (PFBS)	8.3		1.8	0.18	ng/L		09/03/19 19:54	09/06/19 18:26	1
Perfluoropentanesulfonic acid (PFPeS)	3.3		1.8	0.26	ng/L		09/03/19 19:54	09/06/19 18:26	1
Perfluorohexanesulfonic acid (PFHxS)	5.8		1.8	0.15	ng/L		09/03/19 19:54	09/06/19 18:26	1
Perfluoroheptanesulfonic Acid (PFHpS)	ND		1.8	0.17	ng/L		09/03/19 19:54	09/06/19 18:26	1
Perfluorooctanesulfonic acid (PFOS)	12		1.8	0.48	ng/L		09/03/19 19:54	09/06/19 18:26	1
Perfluorononanesulfonic acid (PFNS)	ND		1.8	0.14	ng/L		09/03/19 19:54	09/06/19 18:26	1
Perfluorodecanesulfonic acid (PFDS)	ND		1.8	0.28	ng/L		09/03/19 19:54	09/06/19 18:26	1
Perfluorooctanesulfonamide (FOSA)	ND		1.8	0.31	ng/L		09/03/19 19:54	09/06/19 18:26	1
N-methylperfluorooctanesulfonamidoacetic acid (NMeFOSAA)	ND		18	2.7	ng/L		09/03/19 19:54	09/06/19 18:26	1
N-ethylperfluorooctanesulfonamidoacetic acid (NEtFOSAA)	ND		18	1.7	ng/L		09/03/19 19:54	09/06/19 18:26	1
4:2 FTS	ND		18	4.6	ng/L		09/03/19 19:54	09/06/19 18:26	1
6:2 FTS	ND		18	1.8	ng/L		09/03/19 19:54	09/06/19 18:26	1
8:2 FTS	ND		18	1.8	ng/L		09/03/19 19:54	09/06/19 18:26	1

Isotope Dilution	%Recovery	Qualifier	Limits	Prepared	Analyzed	Dil Fac
13C4 PFBA	71		50 - 150	09/03/19 19:54	09/06/19 18:26	1
13C5 PFPeA	93		50 - 150	09/03/19 19:54	09/06/19 18:26	1
13C2 PFHxA	100		50 - 150	09/03/19 19:54	09/06/19 18:26	1
13C4 PFHpA	102		50 - 150	09/03/19 19:54	09/06/19 18:26	1
13C4 PFOA	98		50 - 150	09/03/19 19:54	09/06/19 18:26	1
13C5 PFNA	99		50 - 150	09/03/19 19:54	09/06/19 18:26	1
13C2 PFDA	99		50 - 150	09/03/19 19:54	09/06/19 18:26	1
13C2 PFUnA	97		50 - 150	09/03/19 19:54	09/06/19 18:26	1
13C2 PFDoA	94		50 - 150	09/03/19 19:54	09/06/19 18:26	1
13C2 PFTeDA	88		50 - 150	09/03/19 19:54	09/06/19 18:26	1
18O2 PFHxS	110		50 - 150	09/03/19 19:54	09/06/19 18:26	1
13C4 PFOS	100		50 - 150	09/03/19 19:54	09/06/19 18:26	1
13C8 FOSA	91		50 - 150	09/03/19 19:54	09/06/19 18:26	1
d3-NMeFOSAA	87		50 - 150	09/03/19 19:54	09/06/19 18:26	1
d5-NEtFOSAA	94		50 - 150	09/03/19 19:54	09/06/19 18:26	1
M2-6:2 FTS	118		50 - 150	09/03/19 19:54	09/06/19 18:26	1
M2-8:2 FTS	108		50 - 150	09/03/19 19:54	09/06/19 18:26	1
M2-4:2 FTS	145		50 - 150	09/03/19 19:54	09/06/19 18:26	1

Eurofins TestAmerica, Sacramento

Client Sample Results

Client: EBA Engineering
Project/Site: OLD PLEASANTON LANDFILL

Job ID: 320-53481-1
SDG: 2512 VINEYARD AVENUE, PLEASANTON, CA.

Client Sample ID: FRB

Lab Sample ID: 320-53481-4

Date Collected: 08/20/19 11:53

Matrix: Water

Date Received: 08/20/19 18:15

Method: EPA 537(Mod) - PFAS for QSM 5.1, Table B-15

Analyte	Result	Qualifier	RL	MDL	Unit	D	Prepared	Analyzed	Dil Fac
Perfluorobutanoic acid (PFBA)	ND		1.7	0.30	ng/L		09/03/19 19:54	09/06/19 18:36	1
Perfluoropentanoic acid (PFPeA)	ND		1.7	0.42	ng/L		09/03/19 19:54	09/06/19 18:36	1
Perfluorohexanoic acid (PFHxA)	ND		1.7	0.50	ng/L		09/03/19 19:54	09/06/19 18:36	1
Perfluoroheptanoic acid (PFHpA)	ND		1.7	0.22	ng/L		09/03/19 19:54	09/06/19 18:36	1
Perfluorooctanoic acid (PFOA)	ND		1.7	0.74	ng/L		09/03/19 19:54	09/06/19 18:36	1
Perfluorononanoic acid (PFNA)	ND		1.7	0.23	ng/L		09/03/19 19:54	09/06/19 18:36	1
Perfluorodecanoic acid (PFDA)	ND		1.7	0.27	ng/L		09/03/19 19:54	09/06/19 18:36	1
Perfluoroundecanoic acid (PFUnA)	ND		1.7	0.95	ng/L		09/03/19 19:54	09/06/19 18:36	1
Perfluorododecanoic acid (PFDoA)	ND		1.7	0.48	ng/L		09/03/19 19:54	09/06/19 18:36	1
Perfluorotridecanoic acid (PFTriA)	ND		1.7	1.1	ng/L		09/03/19 19:54	09/06/19 18:36	1
Perfluorotetradecanoic acid (PFTeA)	ND		1.7	0.25	ng/L		09/03/19 19:54	09/06/19 18:36	1
Perfluorobutanesulfonic acid (PFBS)	ND		1.7	0.17	ng/L		09/03/19 19:54	09/06/19 18:36	1
Perfluoropentanesulfonic acid (PFPeS)	ND		1.7	0.26	ng/L		09/03/19 19:54	09/06/19 18:36	1
Perfluorohexanesulfonic acid (PFHxS)	ND		1.7	0.15	ng/L		09/03/19 19:54	09/06/19 18:36	1
Perfluoroheptanesulfonic Acid (PFHpS)	ND		1.7	0.16	ng/L		09/03/19 19:54	09/06/19 18:36	1
Perfluorooctanesulfonic acid (PFOS)	ND		1.7	0.47	ng/L		09/03/19 19:54	09/06/19 18:36	1
Perfluorononanesulfonic acid (PFNS)	ND		1.7	0.14	ng/L		09/03/19 19:54	09/06/19 18:36	1
Perfluorodecanesulfonic acid (PFDS)	ND		1.7	0.28	ng/L		09/03/19 19:54	09/06/19 18:36	1
Perfluorooctanesulfonamide (FOSA)	ND		1.7	0.30	ng/L		09/03/19 19:54	09/06/19 18:36	1
N-methylperfluorooctanesulfonamidoacetic acid (NMeFOSAA)	ND		17	2.7	ng/L		09/03/19 19:54	09/06/19 18:36	1
N-ethylperfluorooctanesulfonamidoacetic acid (NEtFOSAA)	ND		17	1.6	ng/L		09/03/19 19:54	09/06/19 18:36	1
4:2 FTS	ND		17	4.5	ng/L		09/03/19 19:54	09/06/19 18:36	1
6:2 FTS	ND		17	1.7	ng/L		09/03/19 19:54	09/06/19 18:36	1
8:2 FTS	ND		17	1.7	ng/L		09/03/19 19:54	09/06/19 18:36	1

Isotope Dilution	%Recovery	Qualifier	Limits	Prepared	Analyzed	Dil Fac
13C4 PFBA	93		50 - 150	09/03/19 19:54	09/06/19 18:36	1
13C5 PFPeA	94		50 - 150	09/03/19 19:54	09/06/19 18:36	1
13C2 PFHxA	91		50 - 150	09/03/19 19:54	09/06/19 18:36	1
13C4 PFHpA	95		50 - 150	09/03/19 19:54	09/06/19 18:36	1
13C4 PFOA	94		50 - 150	09/03/19 19:54	09/06/19 18:36	1
13C5 PFNA	92		50 - 150	09/03/19 19:54	09/06/19 18:36	1
13C2 PFDA	93		50 - 150	09/03/19 19:54	09/06/19 18:36	1
13C2 PFUnA	96		50 - 150	09/03/19 19:54	09/06/19 18:36	1
13C2 PFDoA	94		50 - 150	09/03/19 19:54	09/06/19 18:36	1
13C2 PFTeDA	84		50 - 150	09/03/19 19:54	09/06/19 18:36	1
18O2 PFHxS	102		50 - 150	09/03/19 19:54	09/06/19 18:36	1
13C4 PFOS	94		50 - 150	09/03/19 19:54	09/06/19 18:36	1
13C8 FOSA	86		50 - 150	09/03/19 19:54	09/06/19 18:36	1
d3-NMeFOSAA	82		50 - 150	09/03/19 19:54	09/06/19 18:36	1
d5-NEtFOSAA	87		50 - 150	09/03/19 19:54	09/06/19 18:36	1
M2-6:2 FTS	100		50 - 150	09/03/19 19:54	09/06/19 18:36	1
M2-8:2 FTS	100		50 - 150	09/03/19 19:54	09/06/19 18:36	1
M2-4:2 FTS	95		50 - 150	09/03/19 19:54	09/06/19 18:36	1

Eurofins TestAmerica, Sacramento

Isotope Dilution Summary

Client: EBA Engineering
Project/Site: OLD PLEASANTON LANDFILL

Job ID: 320-53481-1
SDG: 2512 VINEYARD AVENUE, PLEASANTON, CA.

Method: EPA 537(Mod) - PFAS for QSM 5.1, Table B-15

Matrix: Water

Prep Type: Total/NA

Percent Isotope Dilution Recovery (Acceptance Limits)

Lab Sample ID	Client Sample ID	PFBA (50-150)	PFPeA (50-150)	PFHxA (50-150)	PFHpA (50-150)	PFOA (50-150)	PFNA (50-150)	PFDA (50-150)	PFUnA (50-150)
320-53481-1	W-9	97	94	97	99	96	96	98	90
320-53481-2	W-14	77	90	94	97	90	92	91	77
320-53481-3	W-6	71	93	100	102	98	99	99	97
320-53481-4	FRB	93	94	91	95	94	92	93	96
LCS 320-320464/2-A	Lab Control Sample	98	97	95	99	95	95	98	94
LCSD 320-320464/3-A	Lab Control Sample Dup	101	101	98	101	98	100	101	101
MB 320-320464/1-A	Method Blank	106	104	102	107	102	103	108	106

Percent Isotope Dilution Recovery (Acceptance Limits)

Lab Sample ID	Client Sample ID	PFDoA (50-150)	PFTDA (50-150)	PFHxS (50-150)	PFOS (50-150)	PFOSA (50-150)	-NMeFOS _i (50-150)	-NEtFOS _i (50-150)	M262FTS (50-150)
320-53481-1	W-9	83	84	106	99	95	87	83	108
320-53481-2	W-14	71	66	101	88	85	79	74	99
320-53481-3	W-6	94	88	110	100	91	87	94	118
320-53481-4	FRB	94	84	102	94	86	82	87	100
LCS 320-320464/2-A	Lab Control Sample	94	85	103	92	88	87	82	100
LCSD 320-320464/3-A	Lab Control Sample Dup	98	86	105	97	91	90	84	103
MB 320-320464/1-A	Method Blank	104	91	112	105	100	103	98	113

Percent Isotope Dilution Recovery (Acceptance Limits)

Lab Sample ID	Client Sample ID	M282FTS (50-150)	M242FTS (50-150)
320-53481-1	W-9	101	99
320-53481-2	W-14	92	110
320-53481-3	W-6	108	145
320-53481-4	FRB	100	95
LCS 320-320464/2-A	Lab Control Sample	101	93
LCSD 320-320464/3-A	Lab Control Sample Dup	106	97
MB 320-320464/1-A	Method Blank	112	103

Surrogate Legend

- PFBA = 13C4 PFBA
- PFPeA = 13C5 PFPeA
- PFHxA = 13C2 PFHxA
- PFHpA = 13C4 PFHpA
- PFOA = 13C4 PFOA
- PFNA = 13C5 PFNA
- PFDA = 13C2 PFDA
- PFUnA = 13C2 PFUnA
- PFDoA = 13C2 PFDoA
- PFTDA = 13C2 PFTeDA
- PFHxS = 18O2 PFHxS
- PFOS = 13C4 PFOS
- PFOSA = 13C8 FOSA
- d3-NMeFOSAA = d3-NMeFOSAA
- d5-NEtFOSAA = d5-NEtFOSAA
- M262FTS = M2-6:2 FTS
- M282FTS = M2-8:2 FTS
- M242FTS = M2-4:2 FTS

QC Sample Results

Client: EBA Engineering
 Project/Site: OLD PLEASANTON LANDFILL

Job ID: 320-53481-1
 SDG: 2512 VINEYARD AVENUE, PLEASANTON, CA.

Method: EPA 537(Mod) - PFAS for QSM 5.1, Table B-15

Lab Sample ID: MB 320-320464/1-A
Matrix: Water
Analysis Batch: 321458

Client Sample ID: Method Blank
Prep Type: Total/NA
Prep Batch: 320464

Analyte	MB Result	MB Qualifier	RL	MDL	Unit	D	Prepared	Analyzed	Dil Fac
Perfluorobutanoic acid (PFBA)	ND		2.0	0.35	ng/L		09/03/19 19:53	09/06/19 17:29	1
Perfluoropentanoic acid (PFPeA)	ND		2.0	0.49	ng/L		09/03/19 19:53	09/06/19 17:29	1
Perfluorohexanoic acid (PFHxA)	ND		2.0	0.58	ng/L		09/03/19 19:53	09/06/19 17:29	1
Perfluoroheptanoic acid (PFHpA)	ND		2.0	0.25	ng/L		09/03/19 19:53	09/06/19 17:29	1
Perfluorooctanoic acid (PFOA)	ND		2.0	0.85	ng/L		09/03/19 19:53	09/06/19 17:29	1
Perfluorononanoic acid (PFNA)	ND		2.0	0.27	ng/L		09/03/19 19:53	09/06/19 17:29	1
Perfluorodecanoic acid (PFDA)	ND		2.0	0.31	ng/L		09/03/19 19:53	09/06/19 17:29	1
Perfluoroundecanoic acid (PFUnA)	ND		2.0	1.1	ng/L		09/03/19 19:53	09/06/19 17:29	1
Perfluorododecanoic acid (PFDoA)	ND		2.0	0.55	ng/L		09/03/19 19:53	09/06/19 17:29	1
Perfluorotridecanoic acid (PFTriA)	ND		2.0	1.3	ng/L		09/03/19 19:53	09/06/19 17:29	1
Perfluorotetradecanoic acid (PFTeA)	ND		2.0	0.29	ng/L		09/03/19 19:53	09/06/19 17:29	1
Perfluorobutanesulfonic acid (PFBS)	ND		2.0	0.20	ng/L		09/03/19 19:53	09/06/19 17:29	1
Perfluoropentanesulfonic acid (PFPeS)	ND		2.0	0.30	ng/L		09/03/19 19:53	09/06/19 17:29	1
Perfluorohexanesulfonic acid (PFHxS)	ND		2.0	0.17	ng/L		09/03/19 19:53	09/06/19 17:29	1
Perfluoroheptanesulfonic Acid (PFHpS)	ND		2.0	0.19	ng/L		09/03/19 19:53	09/06/19 17:29	1
Perfluorooctanesulfonic acid (PFOS)	ND		2.0	0.54	ng/L		09/03/19 19:53	09/06/19 17:29	1
Perfluorononanesulfonic acid (PFNS)	ND		2.0	0.16	ng/L		09/03/19 19:53	09/06/19 17:29	1
Perfluorodecanesulfonic acid (PFDS)	ND		2.0	0.32	ng/L		09/03/19 19:53	09/06/19 17:29	1
Perfluorooctanesulfonamide (FOSA)	ND		2.0	0.35	ng/L		09/03/19 19:53	09/06/19 17:29	1
N-methylperfluorooctanesulfonamidoacetic acid (NMeFOSAA)	ND		20	3.1	ng/L		09/03/19 19:53	09/06/19 17:29	1
N-ethylperfluorooctanesulfonamidoacetic acid (NEtFOSAA)	ND		20	1.9	ng/L		09/03/19 19:53	09/06/19 17:29	1
4:2 FTS	ND		20	5.2	ng/L		09/03/19 19:53	09/06/19 17:29	1
6:2 FTS	ND		20	2.0	ng/L		09/03/19 19:53	09/06/19 17:29	1
8:2 FTS	ND		20	2.0	ng/L		09/03/19 19:53	09/06/19 17:29	1

Isotope Dilution	MB %Recovery	MB Qualifier	Limits	Prepared	Analyzed	Dil Fac
13C4 PFBA	106		50 - 150	09/03/19 19:53	09/06/19 17:29	1
13C5 PFPeA	104		50 - 150	09/03/19 19:53	09/06/19 17:29	1
13C2 PFHxA	102		50 - 150	09/03/19 19:53	09/06/19 17:29	1
13C4 PFHpA	107		50 - 150	09/03/19 19:53	09/06/19 17:29	1
13C4 PFOA	102		50 - 150	09/03/19 19:53	09/06/19 17:29	1
13C5 PFNA	103		50 - 150	09/03/19 19:53	09/06/19 17:29	1
13C2 PFDA	108		50 - 150	09/03/19 19:53	09/06/19 17:29	1
13C2 PFUnA	106		50 - 150	09/03/19 19:53	09/06/19 17:29	1
13C2 PFDoA	104		50 - 150	09/03/19 19:53	09/06/19 17:29	1
13C2 PFTeDA	91		50 - 150	09/03/19 19:53	09/06/19 17:29	1
18O2 PFHxS	112		50 - 150	09/03/19 19:53	09/06/19 17:29	1
13C4 PFOS	105		50 - 150	09/03/19 19:53	09/06/19 17:29	1
13C8 FOSA	100		50 - 150	09/03/19 19:53	09/06/19 17:29	1
d3-NMeFOSAA	103		50 - 150	09/03/19 19:53	09/06/19 17:29	1
d5-NEtFOSAA	98		50 - 150	09/03/19 19:53	09/06/19 17:29	1
M2-6:2 FTS	113		50 - 150	09/03/19 19:53	09/06/19 17:29	1
M2-8:2 FTS	112		50 - 150	09/03/19 19:53	09/06/19 17:29	1
M2-4:2 FTS	103		50 - 150	09/03/19 19:53	09/06/19 17:29	1

Eurofins TestAmerica, Sacramento

QC Sample Results

Client: EBA Engineering
Project/Site: OLD PLEASANTON LANDFILL

Job ID: 320-53481-1
SDG: 2512 VINEYARD AVENUE, PLEASANTON, CA.

Method: EPA 537(Mod) - PFAS for QSM 5.1, Table B-15 (Continued)

Lab Sample ID: LCS 320-320464/2-A
Matrix: Water
Analysis Batch: 321458

Client Sample ID: Lab Control Sample
Prep Type: Total/NA
Prep Batch: 320464

Analyte	Spike Added	LCS Result	LCS Qualifier	Unit	D	%Rec	Limits
Perfluorobutanoic acid (PFBA)	40.0	39.6		ng/L		99	70 - 130
Perfluoropentanoic acid (PFPeA)	40.0	39.4		ng/L		99	66 - 126
Perfluorohexanoic acid (PFHxA)	40.0	39.6		ng/L		99	66 - 126
Perfluoroheptanoic acid (PFHpA)	40.0	40.3		ng/L		101	66 - 126
Perfluorooctanoic acid (PFOA)	40.0	40.1		ng/L		100	64 - 124
Perfluorononanoic acid (PFNA)	40.0	41.0		ng/L		103	68 - 128
Perfluorodecanoic acid (PFDA)	40.0	40.5		ng/L		101	69 - 129
Perfluoroundecanoic acid (PFUnA)	40.0	36.1		ng/L		90	60 - 120
Perfluorododecanoic acid (PFDoA)	40.0	40.5		ng/L		101	71 - 131
Perfluorotridecanoic acid (PFTriA)	40.0	37.3		ng/L		93	72 - 132
Perfluorotetradecanoic acid (PFTeA)	40.0	39.3		ng/L		98	68 - 128
Perfluorobutanesulfonic acid (PFBS)	35.4	34.0		ng/L		96	73 - 133
Perfluoropentanesulfonic acid (PFPeS)	37.5	34.8		ng/L		93	70 - 130
Perfluorohexanesulfonic acid (PFHxS)	36.4	30.9		ng/L		85	63 - 123
Perfluoroheptanesulfonic Acid (PFHpS)	38.1	39.9		ng/L		105	68 - 128
Perfluorooctanesulfonic acid (PFOS)	37.1	36.4		ng/L		98	67 - 127
Perfluorononanesulfonic acid (PFNS)	38.4	41.1		ng/L		107	70 - 130
Perfluorodecanesulfonic acid (PFDS)	38.6	39.8		ng/L		103	68 - 128
Perfluorooctanesulfonamide (FOSA)	40.0	41.6		ng/L		104	70 - 130
N-methylperfluorooctanesulfonamidoacetic acid (NMeFOSAA)	40.0	41.9		ng/L		105	67 - 127
N-ethylperfluorooctanesulfonamidoacetic acid (NEtFOSAA)	40.0	44.1		ng/L		110	65 - 125
4:2 FTS	37.4	39.6		ng/L		106	70 - 130
6:2 FTS	37.9	42.4		ng/L		112	66 - 126
8:2 FTS	38.3	40.3		ng/L		105	67 - 127

Isotope Dilution	LCS %Recovery	LCS Qualifier	Limits
13C4 PFBA	98		50 - 150
13C5 PFPeA	97		50 - 150
13C2 PFHxA	95		50 - 150
13C4 PFHpA	99		50 - 150
13C4 PFOA	95		50 - 150
13C5 PFNA	95		50 - 150
13C2 PFDA	98		50 - 150
13C2 PFUnA	94		50 - 150
13C2 PFDoA	94		50 - 150
13C2 PFTeDA	85		50 - 150
18O2 PFHxS	103		50 - 150
13C4 PFOS	92		50 - 150

Eurofins TestAmerica, Sacramento

QC Sample Results

Client: EBA Engineering
Project/Site: OLD PLEASANTON LANDFILL

Job ID: 320-53481-1
SDG: 2512 VINEYARD AVENUE, PLEASANTON, CA.

Method: EPA 537(Mod) - PFAS for QSM 5.1, Table B-15 (Continued)

Lab Sample ID: LCS 320-320464/2-A
Matrix: Water
Analysis Batch: 321458

Client Sample ID: Lab Control Sample
Prep Type: Total/NA
Prep Batch: 320464

<i>Isotope Dilution</i>	<i>LCS %Recovery</i>	<i>LCS Qualifier</i>	<i>Limits</i>
13C8 FOSA	88		50 - 150
d3-NMeFOSAA	87		50 - 150
d5-NEtFOSAA	82		50 - 150
M2-6:2 FTS	100		50 - 150
M2-8:2 FTS	101		50 - 150
M2-4:2 FTS	93		50 - 150

Lab Sample ID: LCSD 320-320464/3-A
Matrix: Water
Analysis Batch: 321458

Client Sample ID: Lab Control Sample Dup
Prep Type: Total/NA
Prep Batch: 320464

<i>Analyte</i>	<i>Spike Added</i>	<i>LCSD Result</i>	<i>LCSD Qualifier</i>	<i>Unit</i>	<i>D</i>	<i>%Rec</i>	<i>%Rec. Limits</i>	<i>RPD</i>	<i>RPD Limit</i>
Perfluorobutanoic acid (PFBA)	40.0	39.5		ng/L		99	70 - 130	0	30
Perfluoropentanoic acid (PFPeA)	40.0	39.2		ng/L		98	66 - 126	1	30
Perfluorohexanoic acid (PFHxA)	40.0	40.1		ng/L		100	66 - 126	1	30
Perfluoroheptanoic acid (PFHpA)	40.0	40.1		ng/L		100	66 - 126	0	30
Perfluorooctanoic acid (PFOA)	40.0	40.8		ng/L		102	64 - 124	2	30
Perfluorononanoic acid (PFNA)	40.0	40.2		ng/L		100	68 - 128	2	30
Perfluorodecanoic acid (PFDA)	40.0	39.8		ng/L		99	69 - 129	2	30
Perfluoroundecanoic acid (PFUnA)	40.0	36.6		ng/L		92	60 - 120	1	30
Perfluorododecanoic acid (PFDoA)	40.0	39.9		ng/L		100	71 - 131	1	30
Perfluorotridecanoic acid (PFTriA)	40.0	36.9		ng/L		92	72 - 132	1	30
Perfluorotetradecanoic acid (PFTeA)	40.0	38.1		ng/L		95	68 - 128	3	30
Perfluorobutanesulfonic acid (PFBS)	35.4	34.2		ng/L		97	73 - 133	1	30
Perfluoropentanesulfonic acid (PFPeS)	37.5	34.3		ng/L		91	70 - 130	2	30
Perfluorohexanesulfonic acid (PFHxS)	36.4	30.2		ng/L		83	63 - 123	2	30
Perfluoroheptanesulfonic Acid (PFHpS)	38.1	37.8		ng/L		99	68 - 128	5	30
Perfluorooctanesulfonic acid (PFOS)	37.1	36.4		ng/L		98	67 - 127	0	30
Perfluorononanesulfonic acid (PFNS)	38.4	38.1		ng/L		99	70 - 130	8	30
Perfluorodecanesulfonic acid (PFDS)	38.6	38.2		ng/L		99	68 - 128	4	30
Perfluorooctanesulfonamide (FOSA)	40.0	39.2		ng/L		98	70 - 130	6	30
N-methylperfluorooctanesulfonamidoacetic acid (NMeFOSAA)	40.0	42.0		ng/L		105	67 - 127	0	30
N-ethylperfluorooctanesulfonamidoacetic acid (NEtFOSAA)	40.0	43.1		ng/L		108	65 - 125	2	30
4:2 FTS	37.4	39.6		ng/L		106	70 - 130	0	30
6:2 FTS	37.9	41.4		ng/L		109	66 - 126	2	30
8:2 FTS	38.3	39.2		ng/L		102	67 - 127	3	30

QC Sample Results

Client: EBA Engineering
 Project/Site: OLD PLEASANTON LANDFILL

Job ID: 320-53481-1
 SDG: 2512 VINEYARD AVENUE, PLEASANTON, CA.

Method: EPA 537(Mod) - PFAS for QSM 5.1, Table B-15 (Continued)

<i>Isotope Dilution</i>	<i>LCS D LCS D</i>		<i>Limits</i>
	<i>%Recovery</i>	<i>Qualifier</i>	
13C4 PFBA	101		50 - 150
13C5 PFPeA	101		50 - 150
13C2 PFHxA	98		50 - 150
13C4 PFHpA	101		50 - 150
13C4 PFOA	98		50 - 150
13C5 PFNA	100		50 - 150
13C2 PFDA	101		50 - 150
13C2 PFUnA	101		50 - 150
13C2 PFDoA	98		50 - 150
13C2 PFTeDA	86		50 - 150
18O2 PFHxS	105		50 - 150
13C4 PFOS	97		50 - 150
13C8 FOSA	91		50 - 150
d3-NMeFOSAA	90		50 - 150
d5-NEtFOSAA	84		50 - 150
M2-6:2 FTS	103		50 - 150
M2-8:2 FTS	106		50 - 150
M2-4:2 FTS	97		50 - 150

- 1
- 2
- 3
- 4
- 5
- 6
- 7
- 8
- 9
- 10
- 11
- 12
- 13
- 14
- 15

QC Association Summary

Client: EBA Engineering
 Project/Site: OLD PLEASANTON LANDFILL

Job ID: 320-53481-1
 SDG: 2512 VINEYARD AVENUE, PLEASANTON, CA.

LCMS

Prep Batch: 320464

Lab Sample ID	Client Sample ID	Prep Type	Matrix	Method	Prep Batch
320-53481-1	W-9	Total/NA	Water	3535	
320-53481-2	W-14	Total/NA	Water	3535	
320-53481-3	W-6	Total/NA	Water	3535	
320-53481-4	FRB	Total/NA	Water	3535	
MB 320-320464/1-A	Method Blank	Total/NA	Water	3535	
LCS 320-320464/2-A	Lab Control Sample	Total/NA	Water	3535	
LCSD 320-320464/3-A	Lab Control Sample Dup	Total/NA	Water	3535	

Analysis Batch: 321458

Lab Sample ID	Client Sample ID	Prep Type	Matrix	Method	Prep Batch
320-53481-1	W-9	Total/NA	Water	EPA 537(Mod)	320464
320-53481-2	W-14	Total/NA	Water	EPA 537(Mod)	320464
320-53481-3	W-6	Total/NA	Water	EPA 537(Mod)	320464
320-53481-4	FRB	Total/NA	Water	EPA 537(Mod)	320464
MB 320-320464/1-A	Method Blank	Total/NA	Water	EPA 537(Mod)	320464
LCS 320-320464/2-A	Lab Control Sample	Total/NA	Water	EPA 537(Mod)	320464
LCSD 320-320464/3-A	Lab Control Sample Dup	Total/NA	Water	EPA 537(Mod)	320464

Lab Chronicle

Client: EBA Engineering
Project/Site: OLD PLEASANTON LANDFILL

Job ID: 320-53481-1
SDG: 2512 VINEYARD AVENUE, PLEASANTON, CA.

Client Sample ID: W-9

Date Collected: 08/20/19 10:18

Date Received: 08/20/19 18:15

Lab Sample ID: 320-53481-1

Matrix: Water

Prep Type	Batch Type	Batch Method	Run	Dil Factor	Initial Amount	Final Amount	Batch Number	Prepared or Analyzed	Analyst	Lab
Total/NA	Prep	3535			292.3 mL	10.00 mL	320464	09/03/19 19:53	HJA	TAL SAC
Total/NA	Analysis	EPA 537(Mod)		1			321458	09/06/19 18:07	S1M	TAL SAC

Client Sample ID: W-14

Date Collected: 08/20/19 11:20

Date Received: 08/20/19 18:15

Lab Sample ID: 320-53481-2

Matrix: Water

Prep Type	Batch Type	Batch Method	Run	Dil Factor	Initial Amount	Final Amount	Batch Number	Prepared or Analyzed	Analyst	Lab
Total/NA	Prep	3535			294.3 mL	10.00 mL	320464	09/03/19 19:54	HJA	TAL SAC
Total/NA	Analysis	EPA 537(Mod)		1			321458	09/06/19 18:17	S1M	TAL SAC

Client Sample ID: W-6

Date Collected: 08/20/19 12:15

Date Received: 08/20/19 18:15

Lab Sample ID: 320-53481-3

Matrix: Water

Prep Type	Batch Type	Batch Method	Run	Dil Factor	Initial Amount	Final Amount	Batch Number	Prepared or Analyzed	Analyst	Lab
Total/NA	Prep	3535			283.9 mL	10.00 mL	320464	09/03/19 19:54	HJA	TAL SAC
Total/NA	Analysis	EPA 537(Mod)		1			321458	09/06/19 18:26	S1M	TAL SAC

Client Sample ID: FRB

Date Collected: 08/20/19 11:53

Date Received: 08/20/19 18:15

Lab Sample ID: 320-53481-4

Matrix: Water

Prep Type	Batch Type	Batch Method	Run	Dil Factor	Initial Amount	Final Amount	Batch Number	Prepared or Analyzed	Analyst	Lab
Total/NA	Prep	3535			288.3 mL	10.00 mL	320464	09/03/19 19:54	HJA	TAL SAC
Total/NA	Analysis	EPA 537(Mod)		1			321458	09/06/19 18:36	S1M	TAL SAC

Laboratory References:

TAL SAC = Eurofins TestAmerica, Sacramento, 880 Riverside Parkway, West Sacramento, CA 95605, TEL (916)373-5600

Accreditation/Certification Summary

Client: EBA Engineering
 Project/Site: OLD PLEASANTON LANDFILL

Job ID: 320-53481-1
 SDG: 2512 VINEYARD AVENUE, PLEASANTON, CA.

Laboratory: Eurofins TestAmerica, Sacramento

All accreditations/certifications held by this laboratory are listed. Not all accreditations/certifications are applicable to this report.

Authority	Program	Identification Number	Expiration Date
Alaska (UST)	State Program	17-020	01-20-21
ANAB	Dept. of Defense ELAP	L2468	01-20-21
ANAB	Dept. of Energy	L2468.01	01-20-21
ANAB	DoD	L2468	01-20-21
ANAB	DOE	L2468.01	01-20-21
ANAB	ISO/IEC 17025	L2468	08-09-21
Arizona	State	AZ0708	08-11-20
Arizona	State Program	AZ0708	08-11-20
Arkansas DEQ	State Program	88-0691	06-17-20
California	State	2897	01-31-20
California	State Program	2897	01-31-20
Colorado	State	CA0004	08-31-20
Connecticut	State	PH-0691	06-30-21
Connecticut	State Program	PH-0691	06-30-21
Florida	NELAP	E87570	06-30-20
Florida	NELAP	E87570	06-30-20
Hawaii	State	<cert No.>	01-29-20
Hawaii	State Program	N/A	01-29-20
Illinois	NELAP	200060	03-17-20 *
Illinois	NELAP	200060	03-17-20
Kansas	NELAP	E-10375	10-31-19
Louisiana	NELAP	30612	06-30-20
Maine	State Program	CA0004	04-14-20
Michigan	State	9947	01-29-20
Michigan	State Program	9947	01-31-20
New Hampshire	NELAP	2997	04-20-20
New York	NELAP	11666	04-01-20
Oregon	NELAP	4040	01-29-20
Oregon	NELAP	4040	01-29-20
Pennsylvania	NELAP	68-01272	03-31-20
Pennsylvania	NELAP	68-01272	03-31-20
Texas	NELAP	T104704399	05-31-20
Texas	NELAP	T104704399-19-13	05-31-20
US Fish & Wildlife	Federal	LE148388-0	07-31-20
US Fish & Wildlife	US Federal Programs	58448	07-31-20
USDA	Federal	P330-18-00239	01-17-21
USDA	US Federal Programs	P330-18-00239	07-31-21
USEPA UCMR	Federal	CA00044	12-31-20
Utah	NELAP	CA00044	02-29-20
Vermont	State Program	VT-4040	04-16-20
Virginia	NELAP	460278	03-14-20
Virginia	NELAP	460278	03-14-20
Washington	State	C581	05-05-20
Washington	State Program	C581	05-05-20
West Virginia (DW)	State	9930C	12-31-19
West Virginia (DW)	State Program	9930C	12-31-19
Wyoming	State Program	8TMS-L	01-28-19 *

* Accreditation/Certification renewal pending - accreditation/certification considered valid.

Method Summary

Client: EBA Engineering
Project/Site: OLD PLEASANTON LANDFILL

Job ID: 320-53481-1
SDG: 2512 VINEYARD AVENUE, PLEASANTON, CA.

Method	Method Description	Protocol	Laboratory
EPA 537(Mod) 3535	PFAS for QSM 5.1, Table B-15 Solid-Phase Extraction (SPE)	EPA SW846	TAL SAC TAL SAC

Protocol References:

EPA = US Environmental Protection Agency

SW846 = "Test Methods For Evaluating Solid Waste, Physical/Chemical Methods", Third Edition, November 1986 And Its Updates.

Laboratory References:

TAL SAC = Eurofins TestAmerica, Sacramento, 880 Riverside Parkway, West Sacramento, CA 95605, TEL (916)373-5600



Sample Summary

Client: EBA Engineering
Project/Site: OLD PLEASANTON LANDFILL

Job ID: 320-53481-1
SDG: 2512 VINEYARD AVENUE, PLEASANTON, CA.

Lab Sample ID	Client Sample ID	Matrix	Collected	Received	Asset ID
320-53481-1	W-9	Water	08/20/19 10:18	08/20/19 18:15	
320-53481-2	W-14	Water	08/20/19 11:20	08/20/19 18:15	
320-53481-3	W-6	Water	08/20/19 12:15	08/20/19 18:15	
320-53481-4	FRB	Water	08/20/19 11:53	08/20/19 18:15	

1

2

3

4

5

6

7

8

9

10

11

12

13

14

15



DEL-TECH GEOTECHNICAL SUPPORT, INC.

10624 OLIVE AVENUE / OAKDALE, CA. 95361
 (209) 765-2880 / don@deltech1.com

Laboratory Chain of Custody / 2019

BILLING TO:
 EBA ENGINEERING

PROJECT NAME: OLD PLEASANTON LANDFILL / 2512 VINEYARD AVENUE, PLEASANTON, CA.

PROJECT P.O. # 97-609 (TASK 2D)

Sheet: OF

Client: EBA ENGINEERING Report Attention: MIKE DELMANOWSKI Phone: 1.707.544.0784
 Address: 825 SONOMA AVENUE Project Name: OLD PLEASANTON LF REPORT TO: mdelmanowski@ebagroup.com
 City, State, Zip: SANTA ROSA, CA Consultant: EBA ENGINEERING c.c. REPORT TO:

Lab Use Only Sampling Info: Date Time Sample Description / Location DEL-TECH Lab: TESTAMERICA
 S# T #C

S#	T	#C	Date	Time	Sample Description / Location	DEL-TECH	Lab:
			8/20/19	10:18	W-9		Sample Container / Preserv. 2 POLYS NON-PRESERVE
			8/20/19	11:20	W-14		
			8/20/19	12:15	W-6		
			8/20/19	11:55	FRB		
			8/20/19	-	FRB		



Arsenic, Copper, Zinc (6020) ** METALS SAMPLES TO BE FILTERED IN LABORATORY **	VOCs (EPA 8260B)	PAS (EPA 537 Mod.)	EDF REPORTING	Rush Priority (1-Day, 2-Day, 5-Day) STANDARD = (S)
TDS, Chloride, Nitrate (as Nitrate)		X		
		X		
		X		
		X		
		X		

QC Report Type: Level [] 2 [] 3 [] 4 Formal COC Required: []

Signature	Print Name	Company	Time
<i>Mike Delmanowski</i>	MIKE DELMANOWSKI	DEL-TECH GEOTECH.	8/20/19 14:45
<i>Donny Patnam</i>	DONNY PATNAM	EBA	8/20/19 16:15
<i>Salvador Ortega</i>	SALVADOR ORTEGA	EBA	8/20/19 18:15
<i>Salvador Ortega</i>	SALVADOR ORTEGA	EBA	8/20/19 18:15

SPECIAL INSTRUCTIONS / NOTES: PLEASE CONTACT DON LIGHT FOR ANY QUESTIONS ON ANALYSIS REQUESTED / FOR TECHNICAL QUESTIONS CONTACT MIKE DELMANOWSKI AT THE NUMBER LISTED ABOVE.

11.5°C Corr 11.4°C
 Rout of temp 50 8/20/19
 NO TIME
 J R 8/21/19



Login Sample Receipt Checklist

Client: EBA Engineering

Job Number: 320-53481-1

SDG Number: 2512 VINEYARD AVENUE, PLEASANTON, CA.

Login Number: 53481

List Number: 1

Creator: Rosas, Jaime

List Source: Eurofins TestAmerica, Sacramento

Question	Answer	Comment
Radioactivity wasn't checked or is \leq background as measured by a survey meter.	True	
The cooler's custody seal, if present, is intact.	N/A	
Sample custody seals, if present, are intact.	N/A	
The cooler or samples do not appear to have been compromised or tampered with.	True	
Samples were received on ice.	True	
Cooler Temperature is acceptable.	True	Received same day of collection; chilling process has begun.
Cooler Temperature is recorded.	True	
COC is present.	True	
COC is filled out in ink and legible.	True	
COC is filled out with all pertinent information.	True	
Is the Field Sampler's name present on COC?	True	
There are no discrepancies between the containers received and the COC.	False	Sample times not present on COC.
Samples are received within Holding Time (excluding tests with immediate HTs)	True	
Sample containers have legible labels.	True	
Containers are not broken or leaking.	True	
Sample collection date/times are provided.	True	Available by COC.
Appropriate sample containers are used.	True	
Sample bottles are completely filled.	True	
Sample Preservation Verified.	N/A	
There is sufficient vol. for all requested analyses, incl. any requested MS/MSDs	True	
Containers requiring zero headspace have no headspace or bubble is <math><6\text{mm}</math> (1/4").	True	
Multiphasic samples are not present.	True	
Samples do not require splitting or compositing.	True	
Residual Chlorine Checked.	N/A	